

Klipsch®



SB 120

OWNER'S MANUAL

↑ TRIM LINE ↓

↑ TRIM LINE ↓

↓ TRIM LINE ↓

↓ TRIM LINE ↓

WHAT'S INSIDE

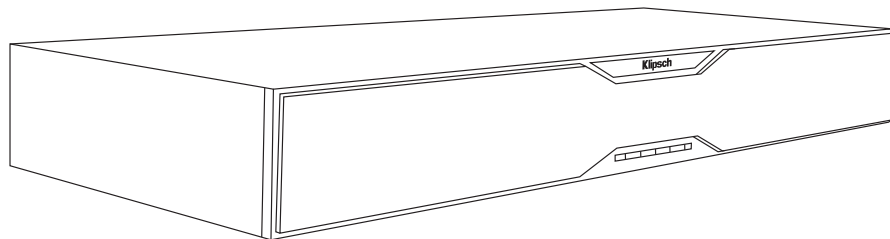

Klipsch SB 120

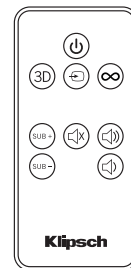

Remote

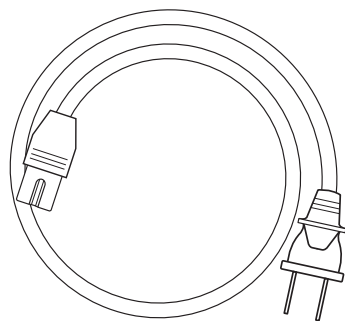

AC Power Cord

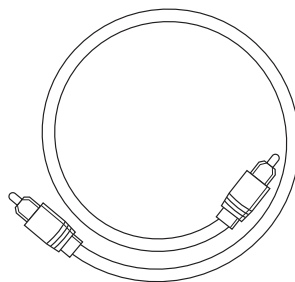

Digital Optical Cable

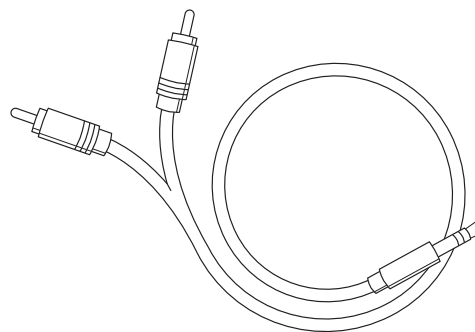

3.5mm to Dual RCA Cable

↑ TRIM LINE ↓

↑ TRIM LINE ↓

DIGITAL OPTICAL CONNECTION (PREFERRED - IF TV HAS NO OPTICAL OUT SEE NEXT PAGE)

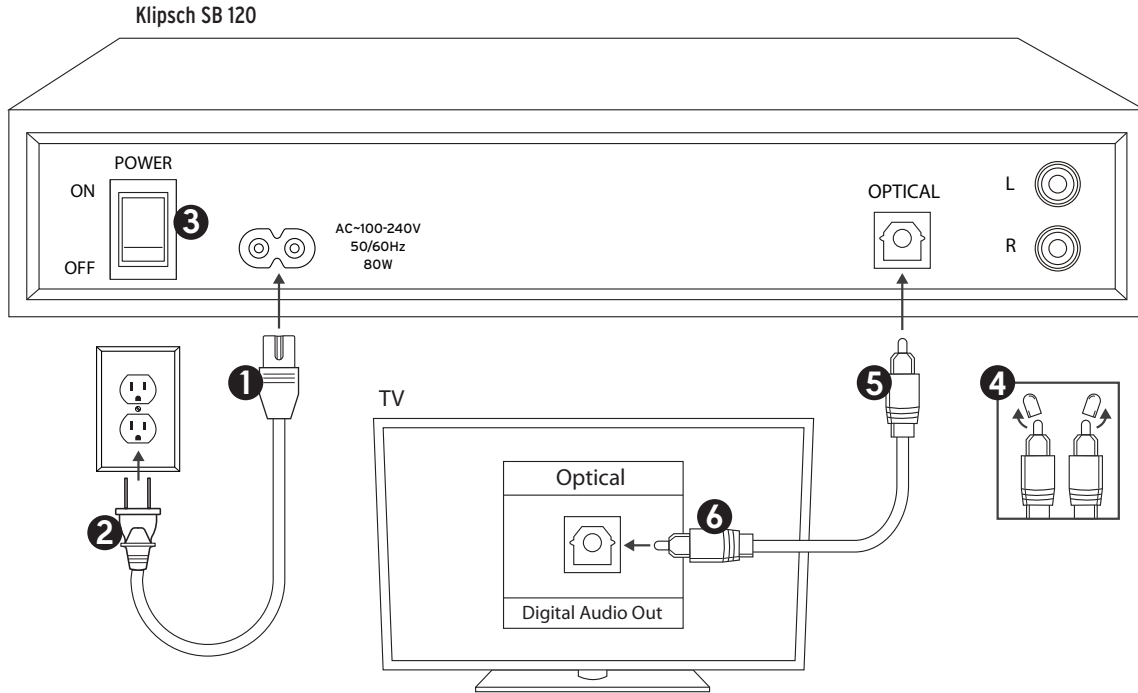

3.5mm TO DUAL RCA ANALOG CONNECTION (IF TV HAS NO HEADPHONE OUT SEE NEXT PAGE)

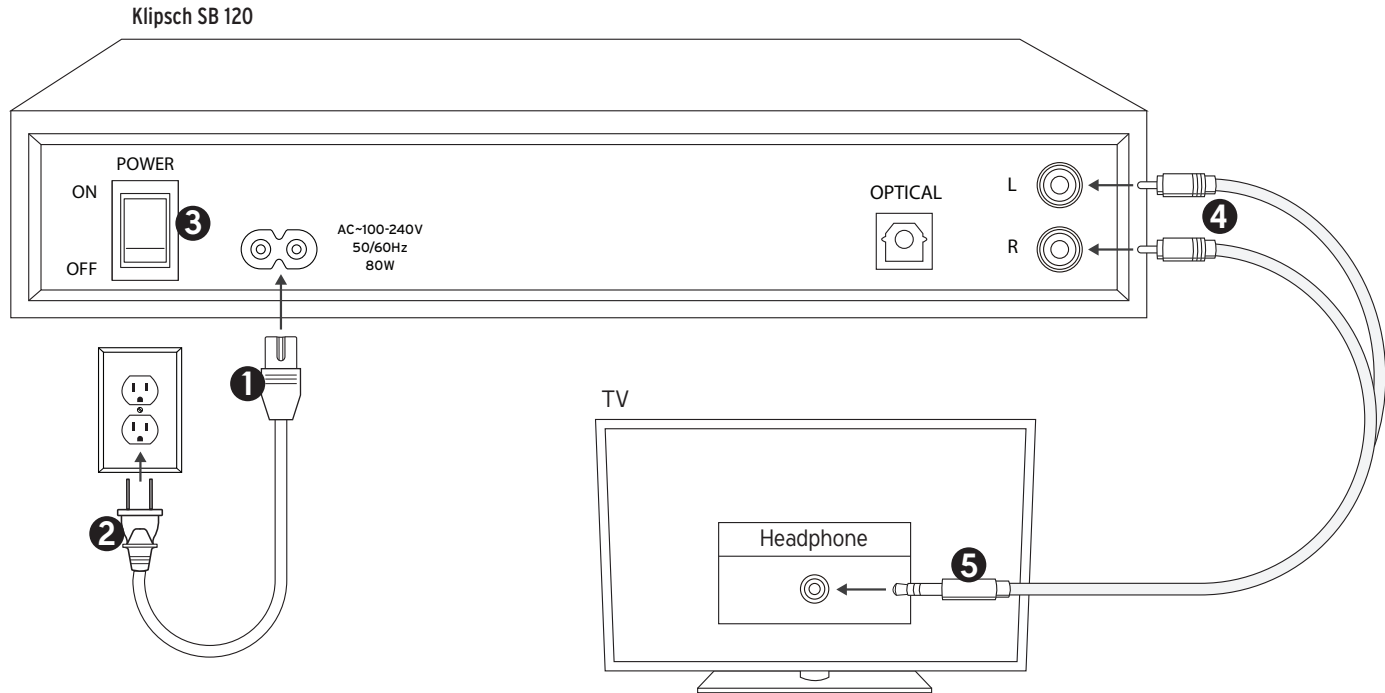

DUAL RCA TO DUAL RCA ANALOG CONNECTION (CABLES NOT INCLUDED)

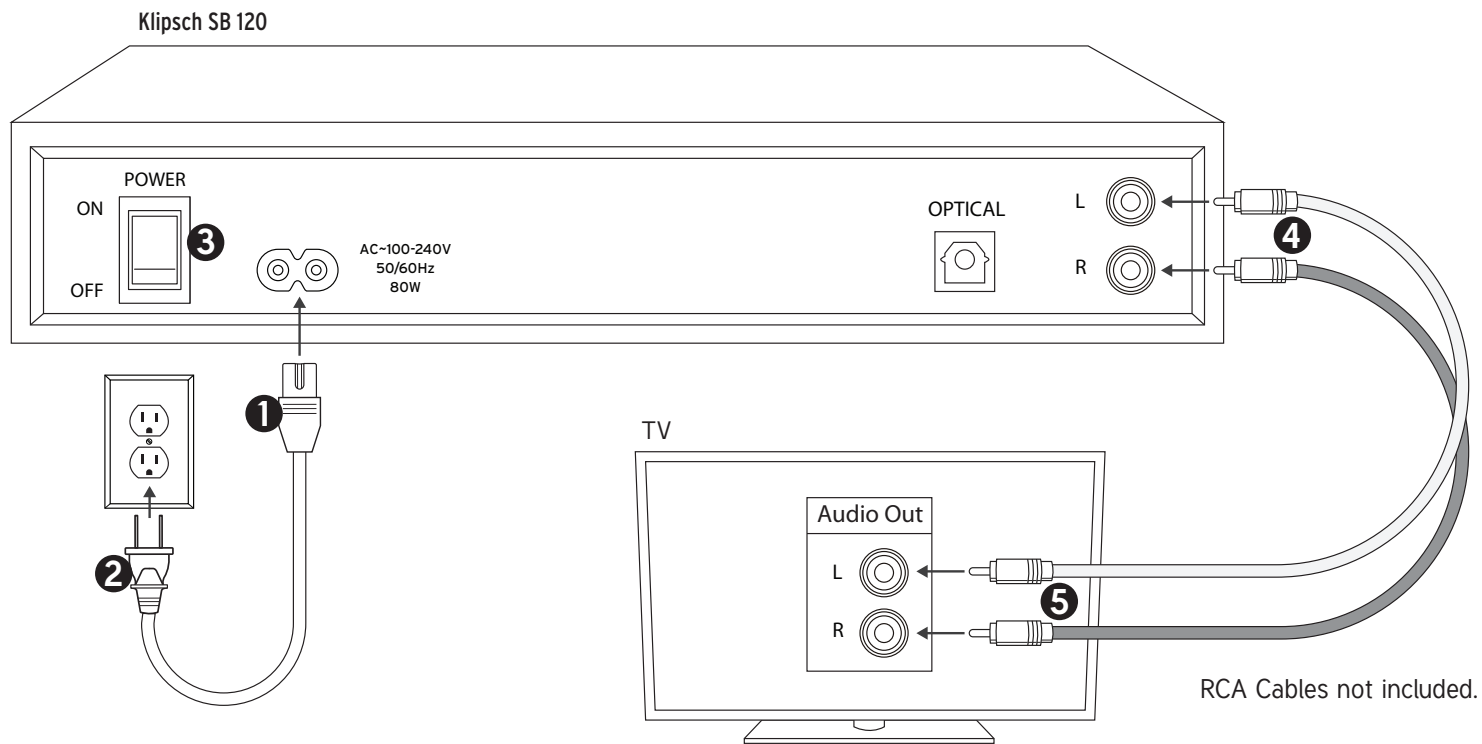

TV REMOTE PROGRAMMING

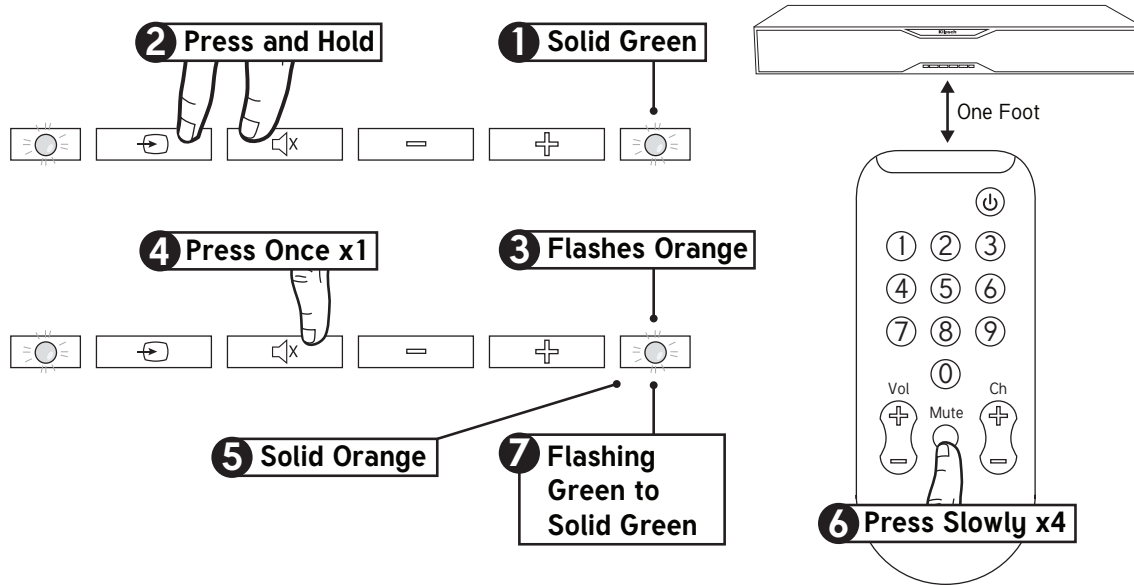

To program Volume Up and Volume Down buttons repeat the steps shown and replace steps 4 and 6 with the button you want to program.

If you are trying to program a cable/satellite box remote or other universal remote without success, please try programming your TV or Cable Box remote instead.

BLUETOOTH® WIRELESS TECHNOLOGY

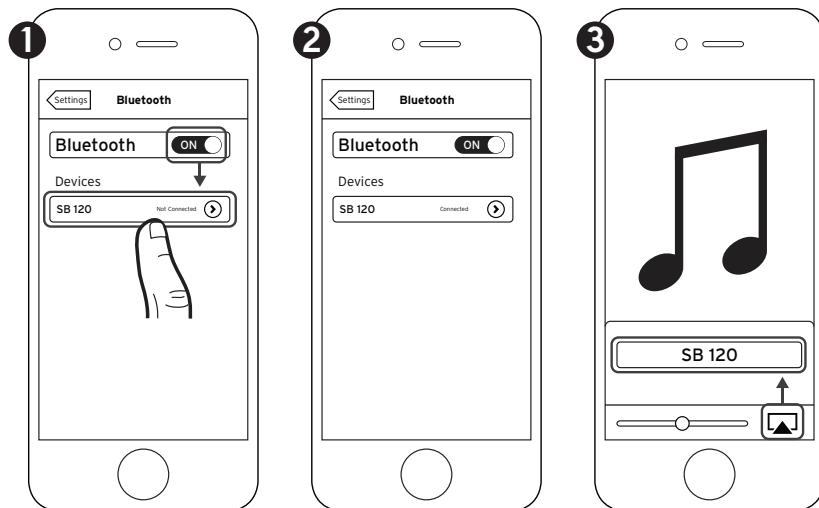

*Example only. Your device may differ.

You can pair a device equipped with *Bluetooth* at any time by activating it on your device.

Once your device equipped with *Bluetooth* is paired, the SB 120 will automatically switch to the *Bluetooth* input (SOLID BLUE LIGHT) and you can stream your music. If you switch inputs on the SB 120, the *Bluetooth* connection will automatically be terminated.

You must disconnect your device before pairing another device equipped with *Bluetooth* by either:

- Pressing and holding the SOURCE button on the SB 120 control panel 3 seconds
- Turning off *Bluetooth* on the paired device
- Pressing the *Bluetooth* button (Ⓜ) on the SB 120 remote

BUTTONS

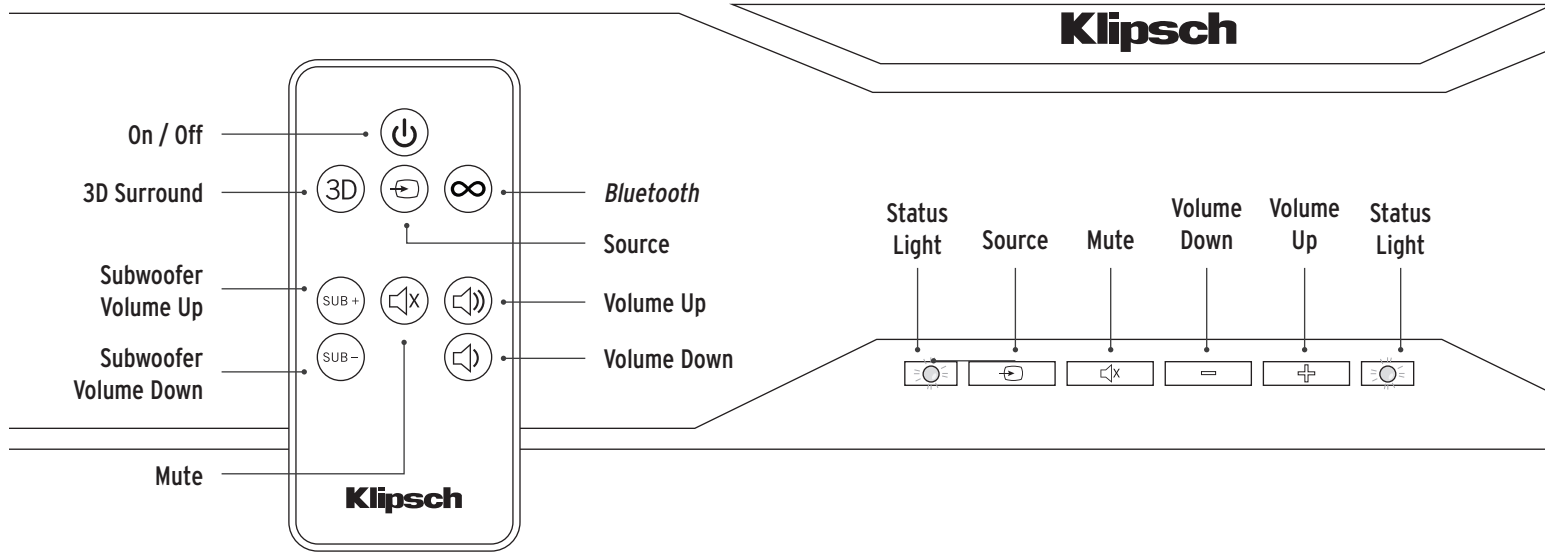

STATUS LIGHTS (RIGHT STATUS LIGHT, UNLESS STATED)

SOLID RED	Power Off (Standby Mode)	FLASHES BLUE QUICKLY	Waiting to pair with <i>Bluetooth</i> device
SOLID GREEN	Power On, Source is Optical Input	FLASHES PURPLE SLOWLY	SB 120 decoding Dolby Digital
SOLID ORANGE	Power On, Source is Analog Input	SOLID WHITE	3D Surround Mode On (Left Status Light)
SOLID BLUE	Power On, Source is Paired <i>Bluetooth</i> device		
FLASHES GREEN / ORANGE / BLUE	Volume Up, Volume Down, Subwoofer Volume Up or Subwoofer Volume Down is pushed		

STANDBY MODE

You do not need to turn off the SB 120, just turn off your TV (or Satellite / Cable Box) and the SB 120 will automatically go into standby mode in approximately 10 minutes.

Standby mode is indicated by a red status light on the front panel. When your TV (or Satellite / Cable Box) is turned back on the SB 120 will automatically turn on again.

PLACEMENT

TV must weigh less than 100 lbs (45kg)

**TV base must be smaller than
31" x 11" (78cm x 28cm)**

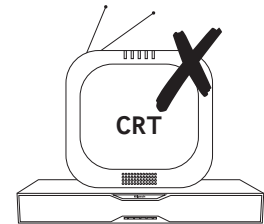
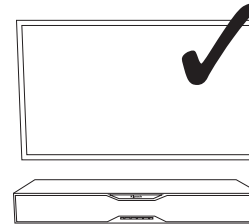
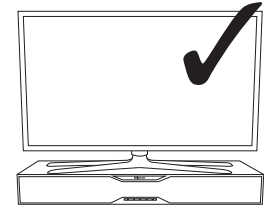
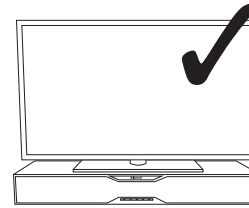
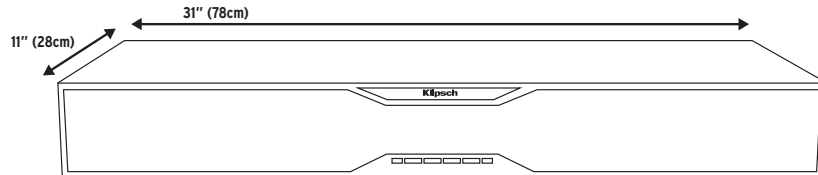

Make sure the rear of the SB 120 is at least one inch away from a back wall and there is at least one inch clearance around the top and sides of the SB 120 for ventilation. Make sure to center your TV on the SB 120.

TURN OFF TV SPEAKERS

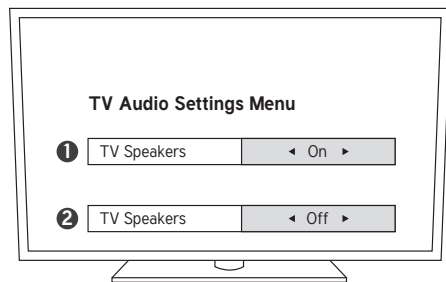

(Recommended)

OR

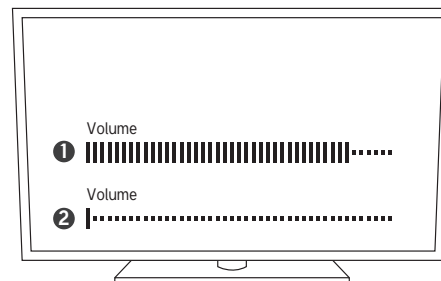

CARE AND CLEANING

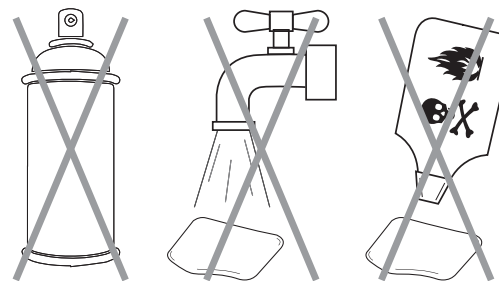
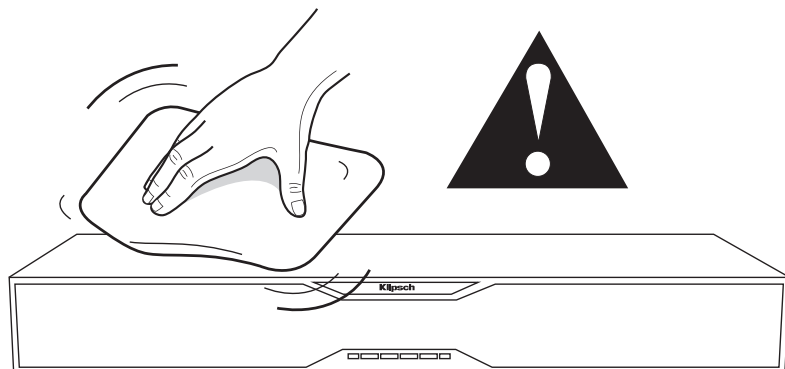

TROUBLESHOOTING

SB 120 will not Power On

- Is it plugged into a live outlet?
- Is the rear power switch on?

No sound

- Is it plugged into a live outlet and the rear power switch is on?
- Are all cables from the TV/Cable Box/Satellite Box plugged in tightly?
- If the optical cable is being used were the clear plastic caps from both ends removed before connecting?
- Is the volume turned up?
- Is standby off (no SOLID RED status light)?
- Is the source input correct?
- Turn off the rear power switch, then back on.

TV/Cable/Satellite Box Remote will not program

- Carefully follow all remote programming instructions.
- Carefully go through the remote programming again, but **use the original remote that comes with the TV**. You DO NOT need to then reprogram using your cable/satellite/universal remote control.
- Program the original TV remote to the SB 120 (if original is a different one), then use the universal remote without programming it.
- You may need to repeat programming of a function in some cases.
- There may be some cases the SB 120 is unable to learn certain remote codes.

Bluetooth does not work

- Is the device paired to the SB 120?
- Move your device closer to the SB 120 and make sure it is paired.
- If the status light blinks RED while attempting to pair, start the pairing process over.



Manufactured under license from Dolby Laboratories. Dolby and the double-D symbol are registered trademarks of Dolby Laboratories.

The *Bluetooth*® word mark and logos are registered trademarks owned by *Bluetooth* SIG, Inc. and any use of such marks by Klipsch Group, Inc. is under license.

COMPOSANTS INCLUS

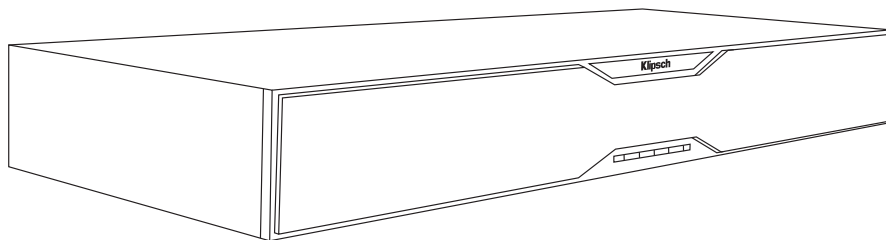

Klipsch SB 120

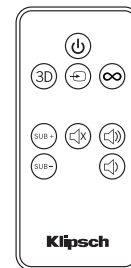

Télécommande

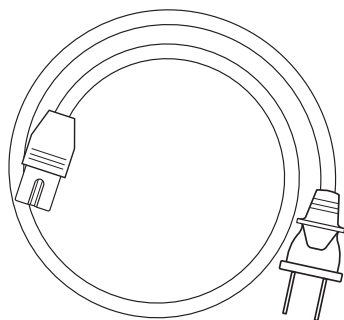

Cordon d'alimentation c.a.

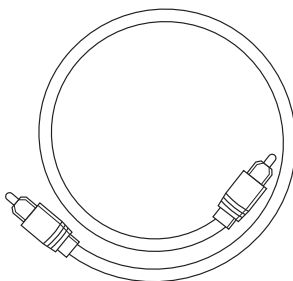

Câble optique numérique

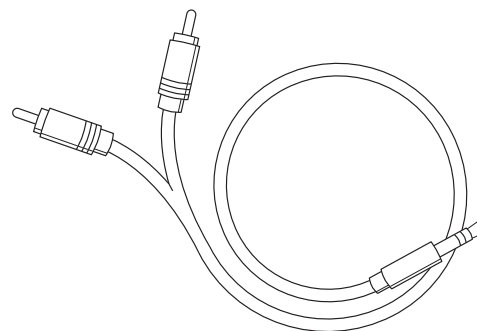

Câble 3,5 mm vers double fiche RCA

CONNEXION OPTIQUE NUMÉRIQUE (RECOMMANDÉE - SI LE TÉLÉVISEUR N'A PAS DE SORTIE OPTIQUE, VOIR PAGE SUIVANTE)

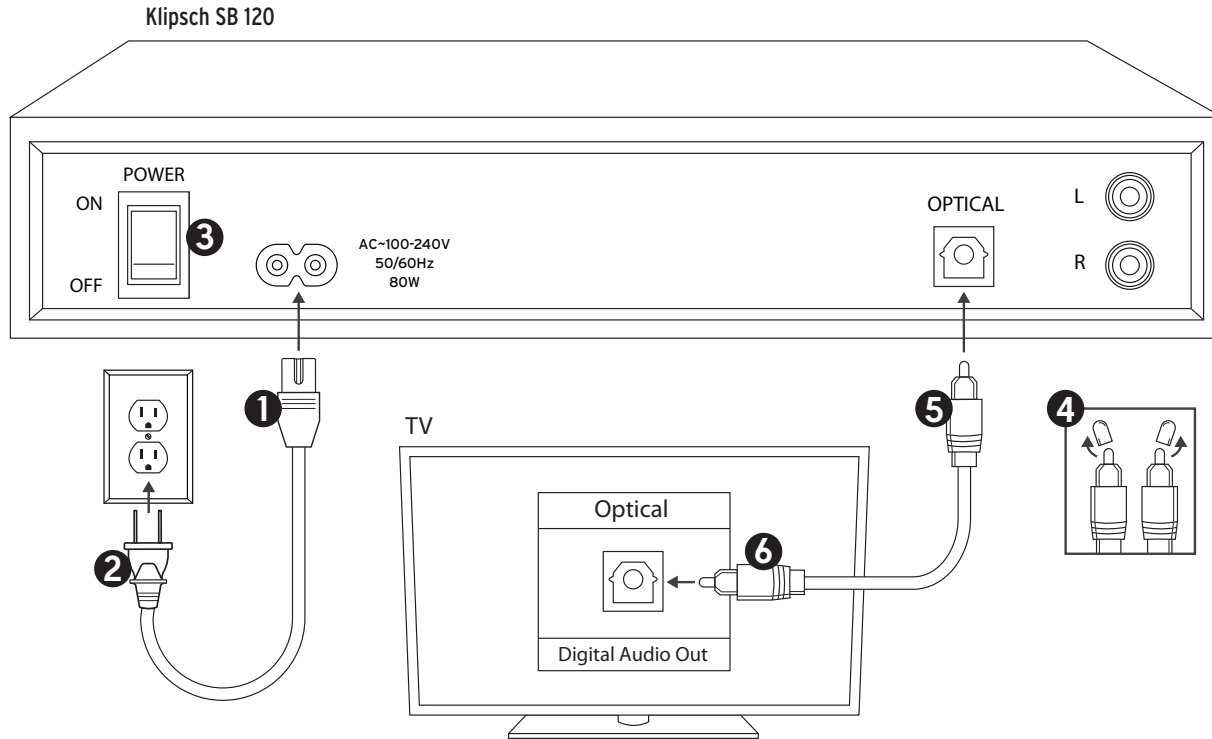

CONNEXION ANALOGIQUE 3,5 MM VERS DOUBLE FICHE RCA

(SI LE TÉLÉVISEUR N'A PAS DE SORTIE POUR CASQUE D'ÉCOUTE, VOIR PAGE SUIVANTE)

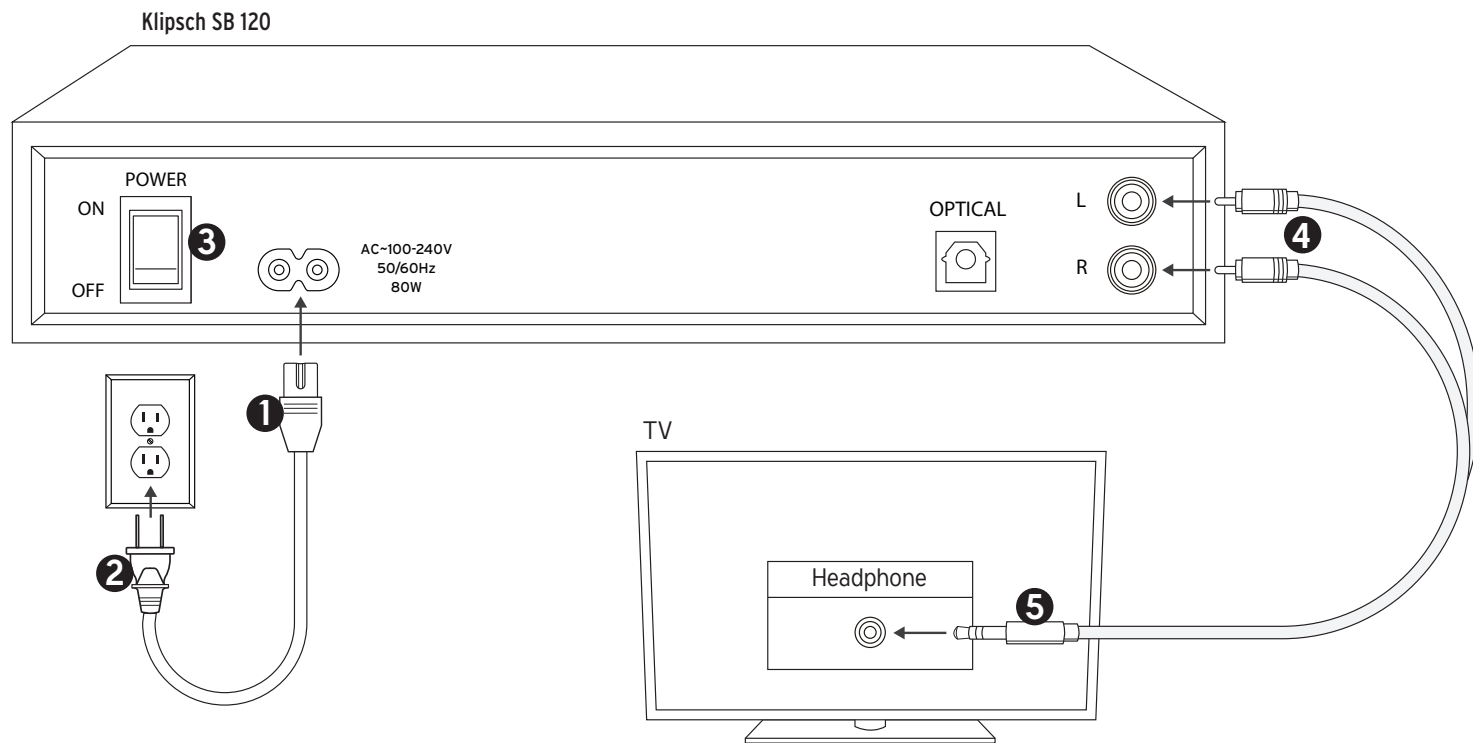

CONNEXION ANALOGUE DOUBLE FICHE RCA VERS DOUBLE FICHE RCA

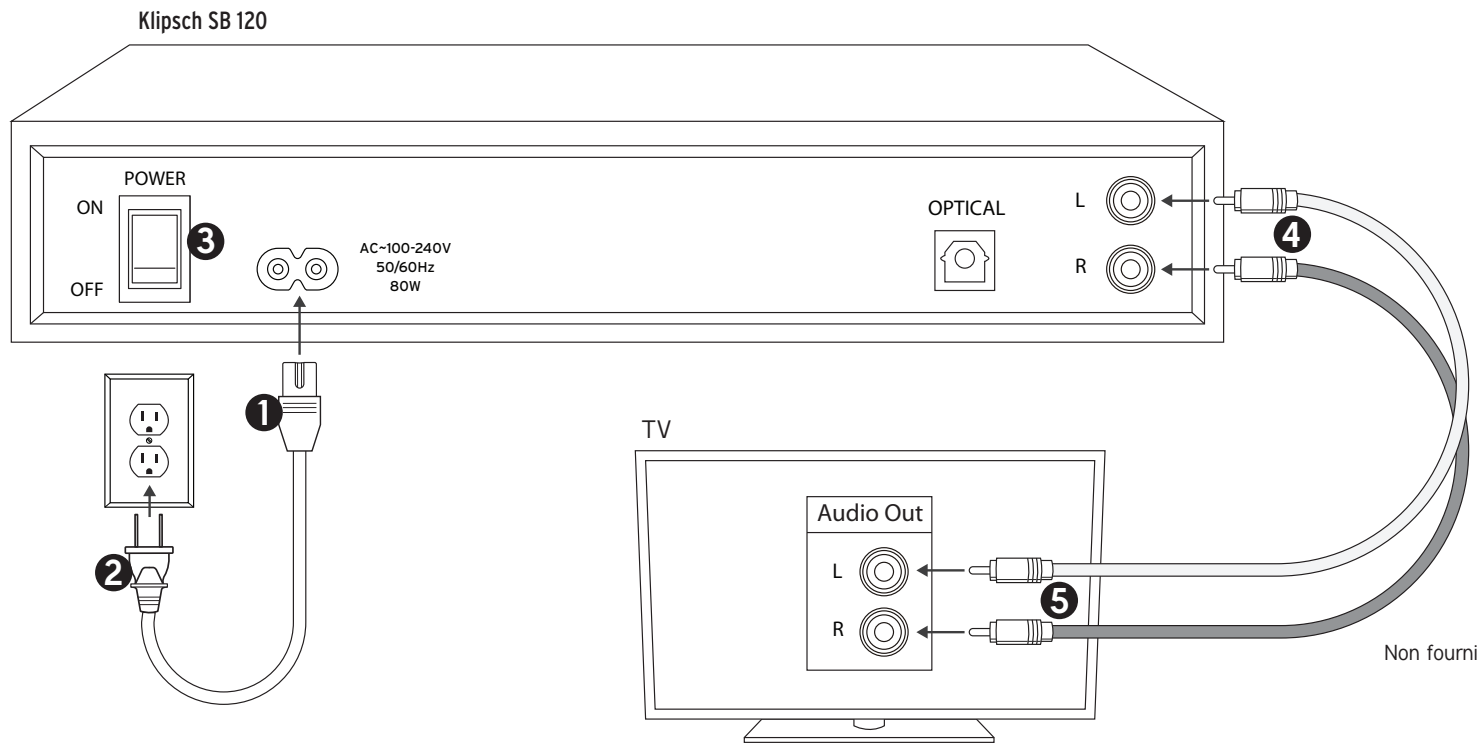

PROGRAMMATION À DISTANCE DU TÉLÉVISEUR

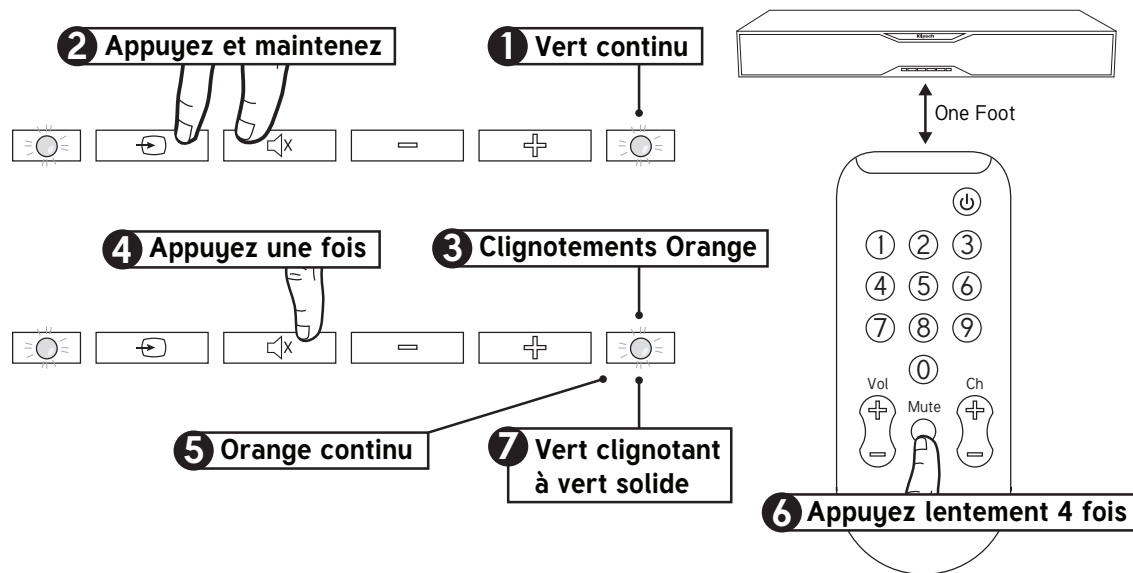

Pour régler les boutons pour augmenter et réduire le volume, répétez les étapes indiquées et remplacez les étapes 4 et 6 par le bouton que vous souhaitez programmer.

Si vous n'arrivez pas à programmer une télécommande

de décodeur satellite ou de câblodistribution ou une autre télécommande universelle, essayez de programmer la télécommande de votre téléviseur ou de votre décodeur de câblodistribution.

TECHNOLOGIE SANS FIL W®

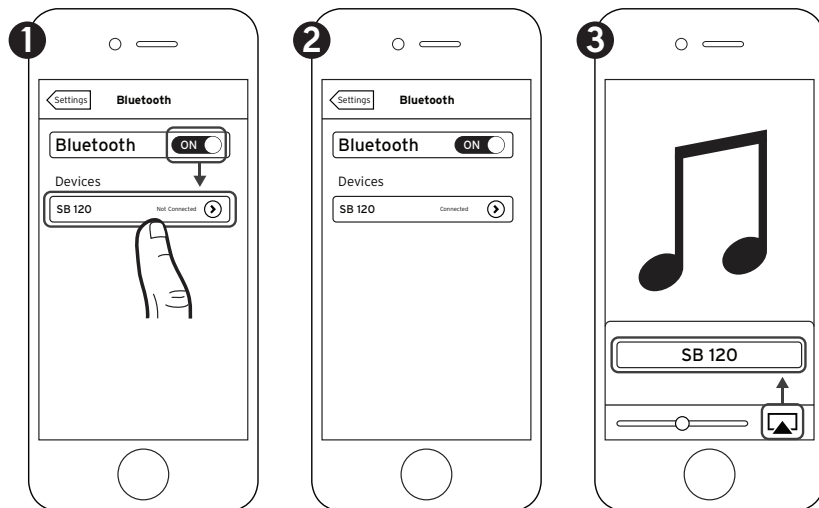

*À titre d'exemple seulement. Votre appareil peut être différent.

Vous pouvez appairer un appareil *Bluetooth* à tout moment en activant *Bluetooth* sur votre appareil.

Une fois l'appareil *Bluetooth* apparié, SB 120 bascule automatiquement sur l'entrée *Bluetooth* (VOYANT BLEU CONTINU) et vous pouvez procéder à la diffusion de votre musique. Si vous changez d'entrée sur SB 120, la connexion *Bluetooth* se termine automatiquement.

Vous devez déconnecter un appareil *Bluetooth* avant d'appairer un autre appareil *Bluetooth*, en procédant suivant l'une de ces méthodes :

- Appuyez sur le bouton SOURCE sur le panneau de commande de SB 120 et maintenez-le enfoncé pendant 3 secondes
- Désactivez *Bluetooth* sur le dispositif apparié.
- Appuyez sur le bouton *Bluetooth* sur la télécommande de SB 120

TOUCHES

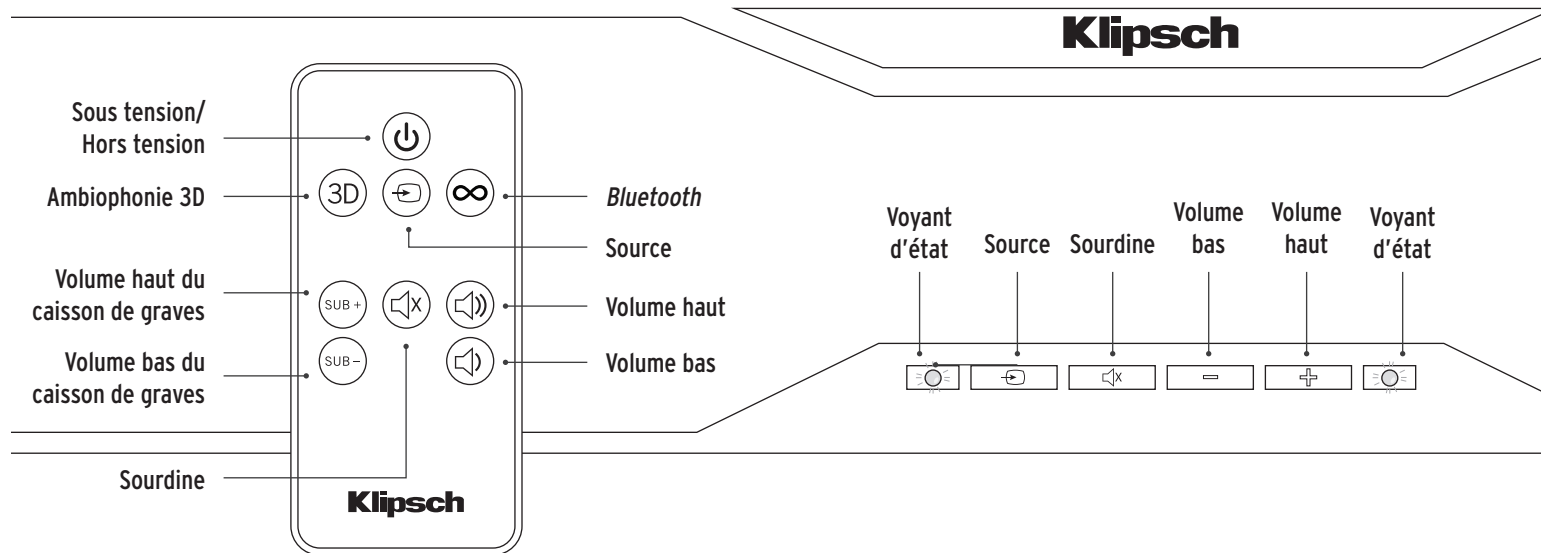

VOYANTS D'ÉTAT (VOYANT D'ÉTAT DE DROIT, À MOINS D'INDICATION)

ROUGE CONTINU	Hors tension (mode Veille)	CLIGNOTE UNE FOIS EN VERT	Ambiophonie 3D activée
VERT CONTINU	Sous tension, la source est l'entrée optique	CLIGNOTE UNE FOIS EN ROUGE	Ambiophonie 3D désactivée
ORANGE CONTINU	Sous tension, la source est l'entrée analogique	CLIGNOTE RAPIDEMENT EN BLEU	En attente d'appariement avec un appareil <i>Bluetooth</i>
BLEU CONTINU	Sous tension, la source est un appareil apparié <i>Bluetooth</i>	BLANC (VOYANT D'ÉTAT DROIT)	En mode ambiophonique 3D
CLIGNOTE EN VERT / ORANGE / BLEU	Volume haut, volume bas, volume haut du caisson de graves ou volume bas du caisson de graves est activé		

MODE VEILLE

Vous n'avez pas à mettre SB 120 hors tension. Il suffit d'éteindre votre téléviseur (ou votre décodeur satellite ou de câblodistribution) et SB 120 passe alors automatiquement en mode Veille au bout d'environ 10 minutes.

L'activation du mode Veille est indiquée par un voyant d'état rouge sur le panneau avant. Quand votre téléviseur (ou votre décodeur satellite ou de câblodistribution) est remis en marche, SB 120 passe automatiquement sous tension.

PLACEMENT

**Le poids du téléviseur doit être
inférieur à 45 kg**

**La taille de la base du téléviseur doit être
inférieure à 78 cm x 28 cm**

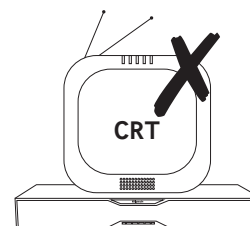
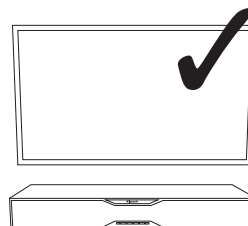
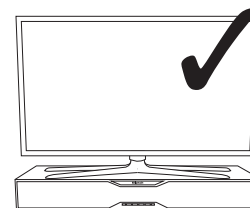
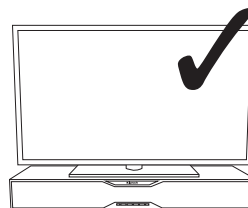
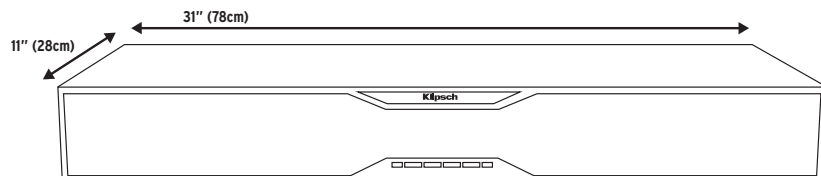

Assurez-vous que SB 120 a un dégagement d'au moins 2,5 cm par rapport au mur arrière ainsi que sur le haut et sur les côtés pour permettre la ventilation.

MISE HORS TENSION DES HAUT-PARLEURS DU TÉLÉVISEUR



(Recommandé)

OU

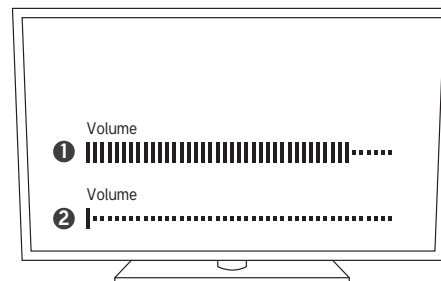

ENTRETIEN ET NETTOYAGE

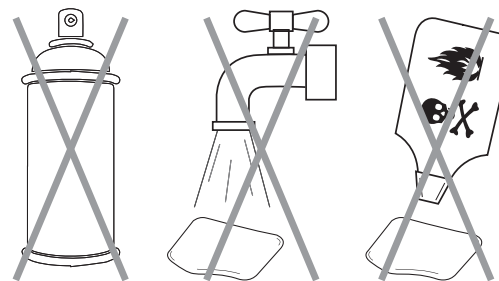
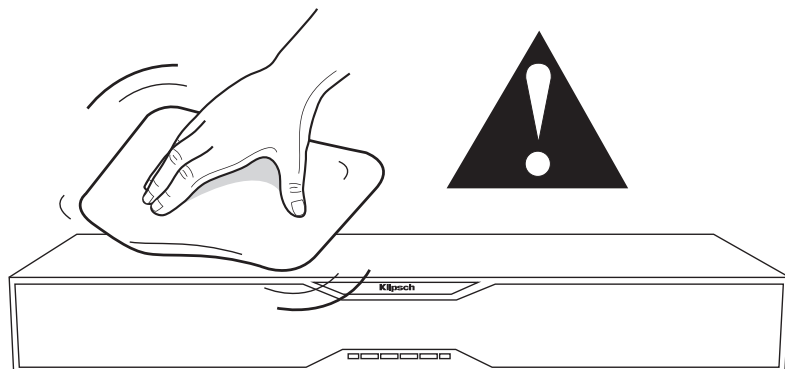

EN CAS DE DIFFICULTÉ

SB 120 ne passe pas sous tension

- Est-elle branchée dans une prise sous tension alimentée ?
- L'interrupteur arrière est-il sur la position de mise sous tension ?

- **Aucun son**
- Est-elle branchée dans une prise sous tension alimentée et l'interrupteur arrière de l'alimentation principale est-il sur la position de mise sous tension ?
- Tous les câbles du téléviseur/décodeur satellite ou câblodistribution sont-ils insérés à fond ?
- Si le câble optique est utilisé, les capuchons en plastique à l'extrémité du câble ont-ils été retirés ?
- Le volume est-il réglé à un niveau audible ?
- Le mode veille est-il désactivé (pas de voyant d'état ROUGE CONTINU) ?
- La source d'entrée est-elle correcte ?
- Faites passer l'interrupteur d'alimentation arrière sur la position hors tension, puis remplacez-le sur la position de mise sous tension.

La télécommande du téléviseur/du décodeur satellite ou de câblodistribution ne se programme pas

- Suivez strictement toutes les instructions de programmation.
- Revoyez avec attention la programmation à distance mais utilisez la télécommande d'origine qui est livrée avec le téléviseur. VOUS N'AVEZ PAS BESOIN de reprogrammer ensuite en utilisant votre télécommande de câblodistribution/satellite/universelle.

- Programmez la télécommande d'origine du téléviseur par rapport à SB 120 (si celle d'origine est différente), puis utilisez la télécommande universelle sans la programmer.
- Il peut s'avérer nécessaire de répéter la programmation d'une fonction dans certains cas.
- Il est possible que, dans certains cas, l'Klipsch SB 120 ne puisse pas lire les codes de certaines télécommandes.

La transmission *Bluetooth* ne fonctionne pas

- L'appareil *Bluetooth* est-il apparié à SB 120 ?
- Rapprochez l'appareil *Bluetooth* de SB 120 et assurez-vous qu'il est apparié.
- Si le voyant d'état clignote en ROUGE lorsque vous tentez d'apparier, recommencez le processus d'appariement depuis le début.

Pour toute question, contactez le service client Energy :

Aux États-Unis : 1-866-441-8208



Fabrication sous licence de Dolby Laboratories. Dolby et le symbole double-D sont des marques de commerce déposées de Dolby Laboratories.

La marque et les logos du mot *Bluetooth*® sont des marques de commerce déposées, propriétés de *Bluetooth SIG, Inc.* et l'utilisation de ces marques par Klipsch Group, Inc. fait l'objet d'une licence.



CONTENIDO

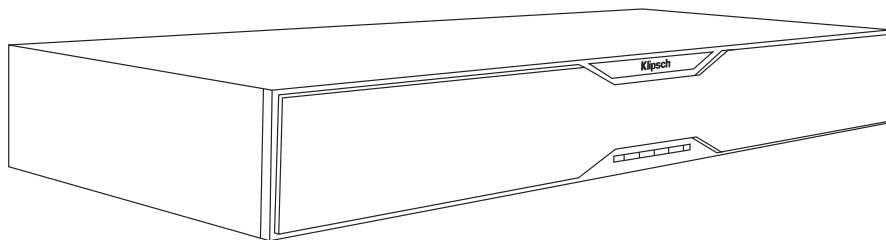

Klipsch SB 120

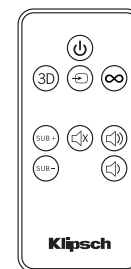

Control remoto

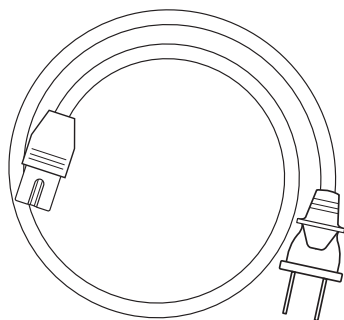

Cordón de alimentación de corriente alterna (CA)

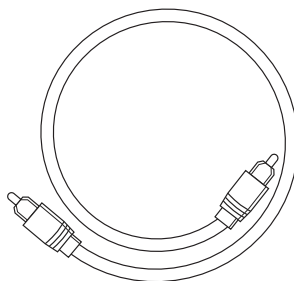

Cable óptico digital

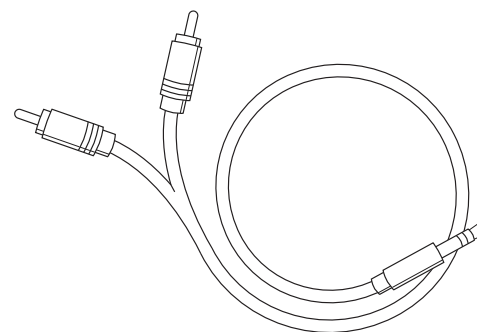

Cable de 3.5 mm a dos RCA

CONEXIÓN ÓPTICA DIGITAL (PREFERIDA. SI EL TELEVISOR NO TIENE SALIDA ÓPTICA, VEA LA PÁGINA SIGUIENTE)

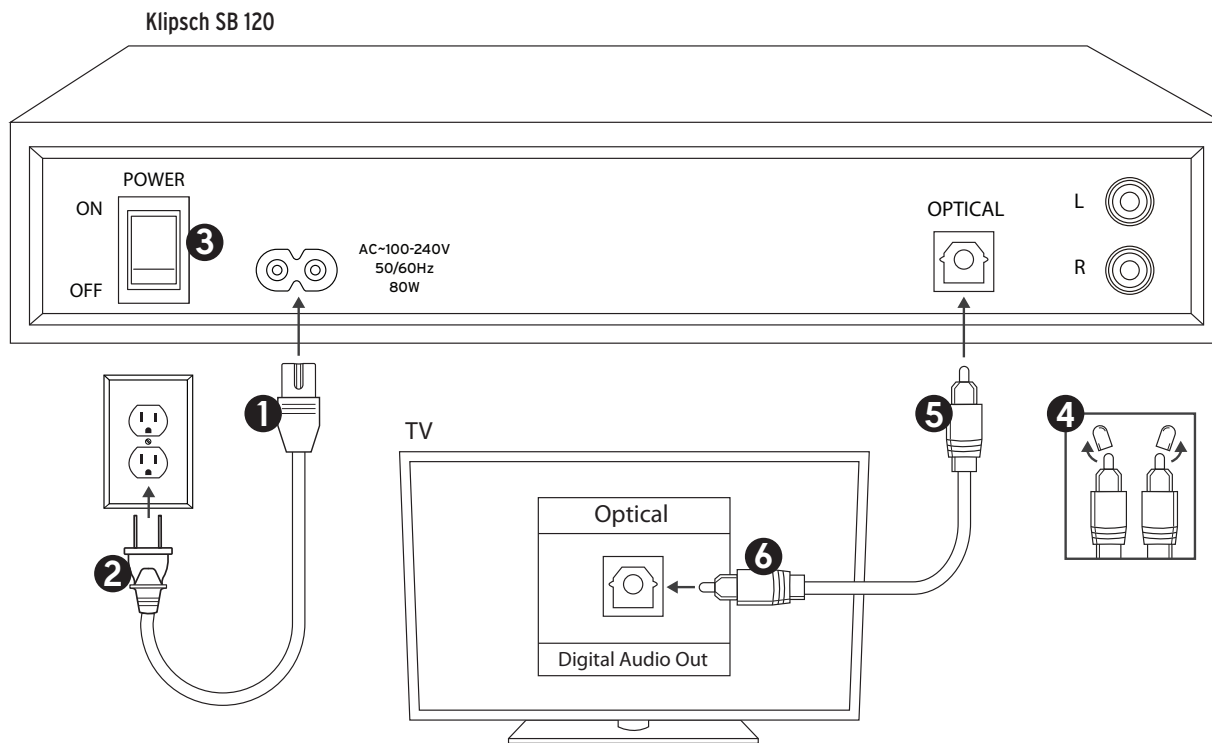

CONEXIÓN ANALÓGICA RCA DE 3.5 MM A DOS RCA

(SI EL TELEVISOR NO TIENE SALIDA DE AURICULARES, VEA LA PÁGINA SIGUIENTE)

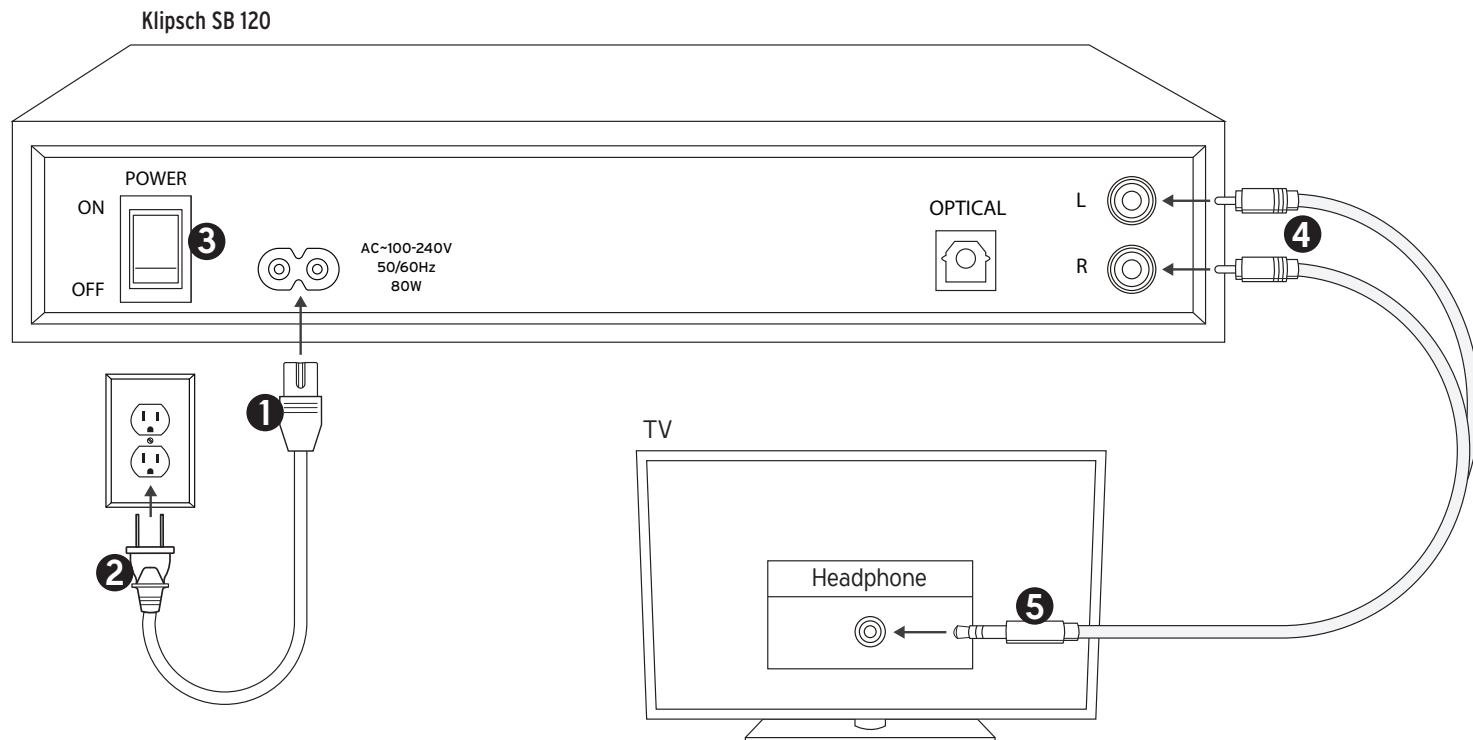

CONEXIÓN ANALÓGICA DE DOS RCA A DOS RCA

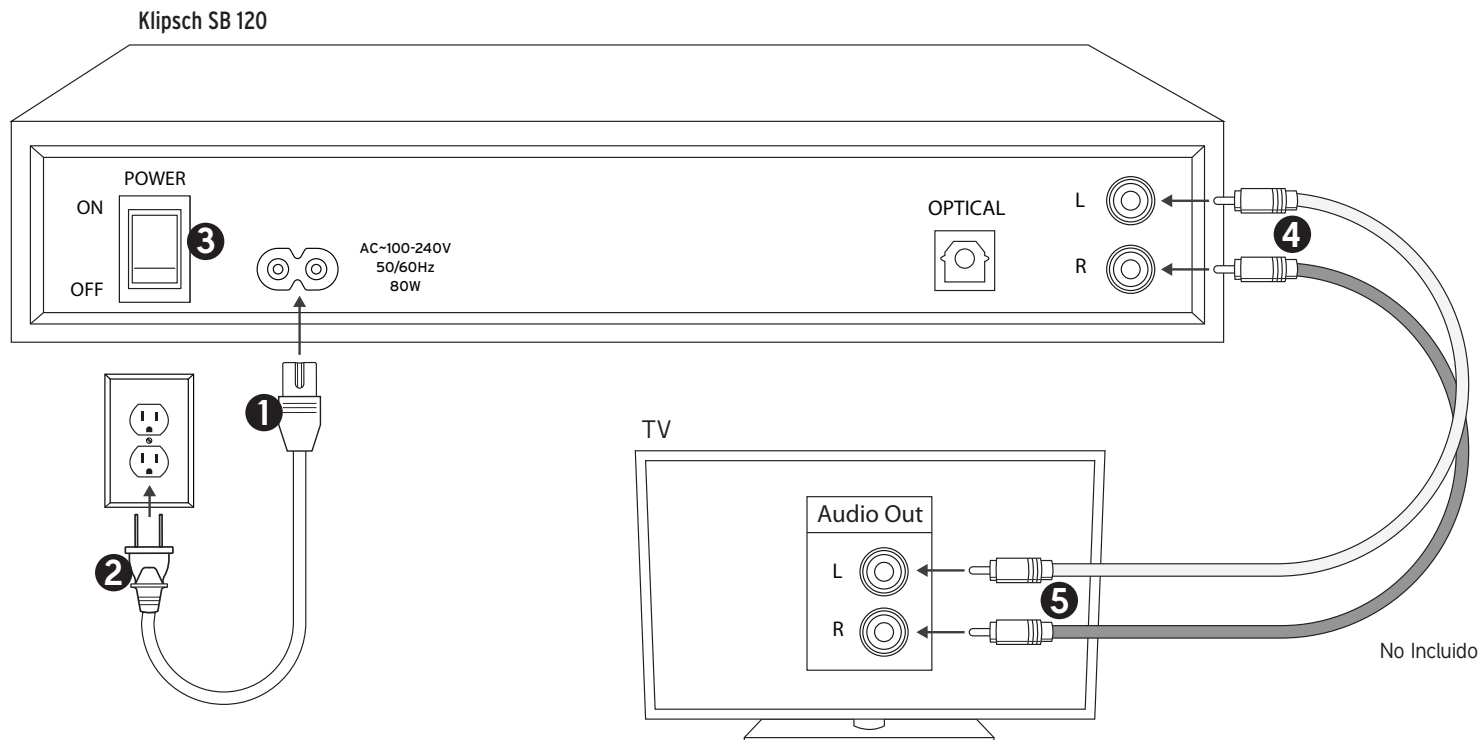

PROGRAMACIÓN DEL CONTROL REMOTO DEL TELEVISOR

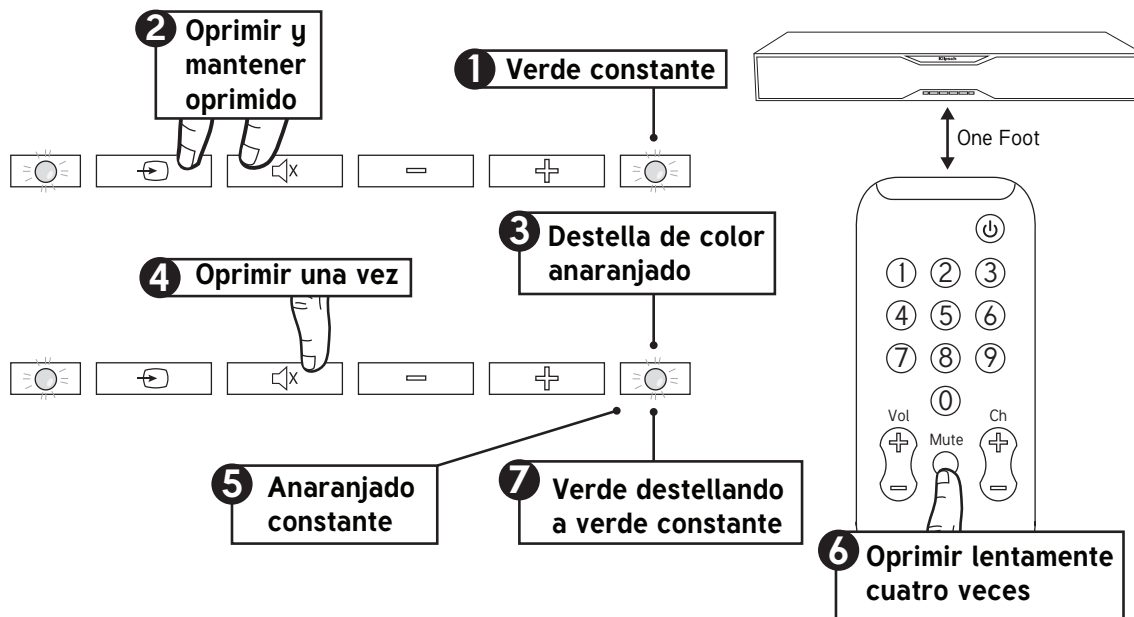

Para programar los botones de subida y bajada de volumen, repita los procedimientos que se indican cambiando los pasos 4 y 6 de manera que correspondan al botón que desea programar.

Si está intentando programar un control remoto de caja de televisión por cable o satélite u otro control remoto universal y no lo logra, intente programar el control remoto de su televisor o caja de televisión por cable.

TECNOLOGÍA INALÁMBRICA *BLUETOOTH*[®]

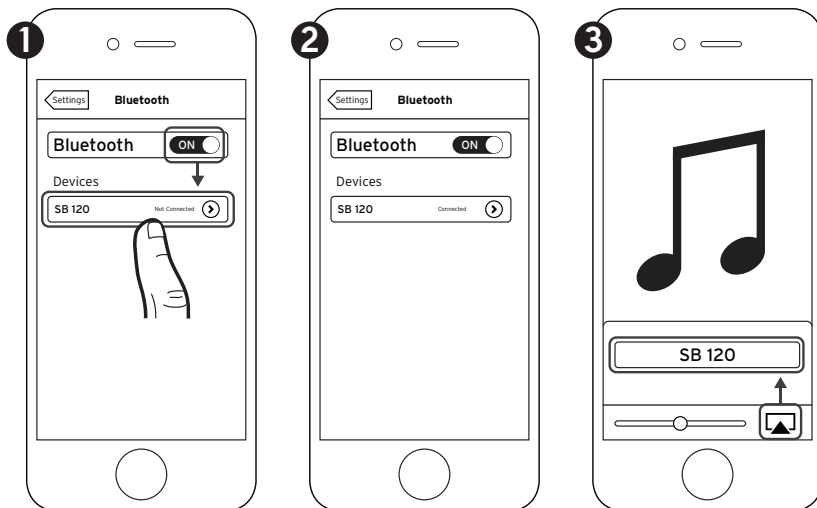

*Este es solo un ejemplo. Es posible que su dispositivo sea diferente..

Se puede sincronizar un dispositivo *Bluetooth* en cualquier momento activándole la función *Bluetooth*.

Una vez que el dispositivo *Bluetooth* se sincroniza, la SB 120 pasa automáticamente a la entrada de *Bluetooth* (LUZ AZUL CONSTANTE) y se puede hacer fluir música. Si cambia de entrada en la SB 120, la conexión *Bluetooth* se termina automáticamente.

Se debe desconectar un dispositivo *Bluetooth* antes de sincronizar otro, lo cual se puede hacer de una de las siguientes maneras:

- Oprimir y mantener oprimido durante tres segundos el botón de fuente (SOURCE) del panel de control de la SB 120
- Desactivar la función *Bluetooth* del dispositivo sincronizado
- Oprimir el botón *Bluetooth* del control remoto de la SB 120

BOTONES

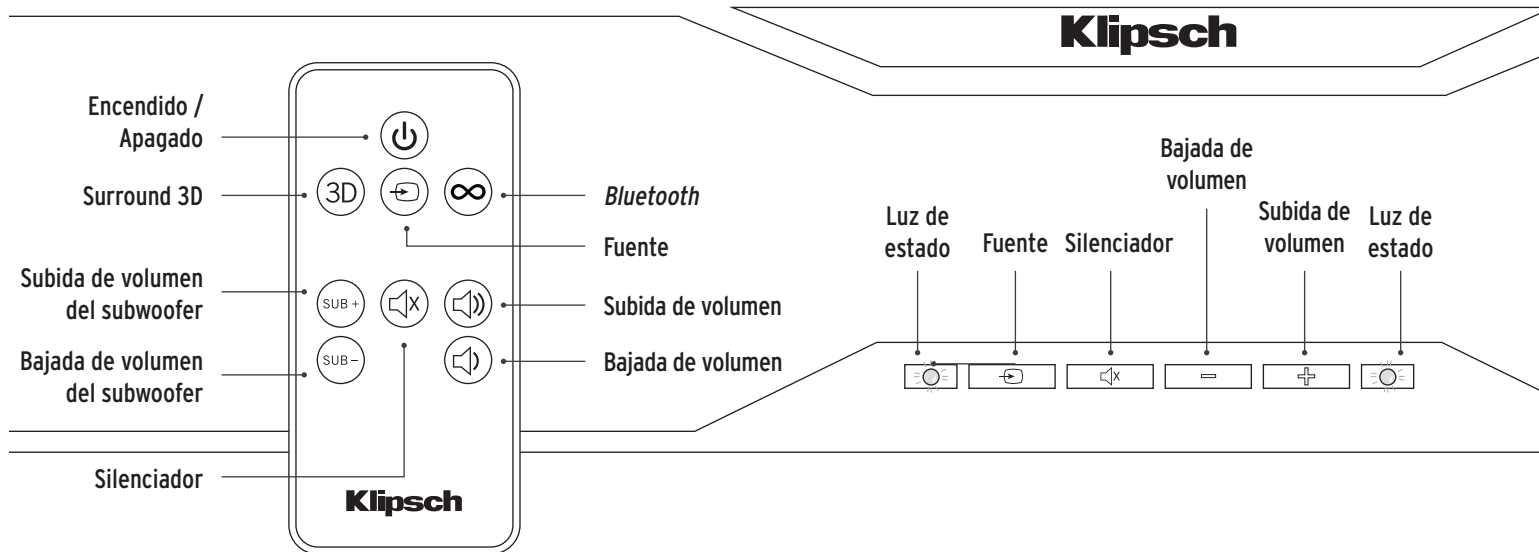

LUCES DE ESTADO (LUZ DE ESTADO DE DERECHO, SALVO INDICACIÓN)

ROJO CONSTANTE	Apagado (modalidad de espera)	DESTELLO VERDE UNA VEZ	Surround 3D activado
VERDE CONSTANTE	Encendido, la fuente es la entrada óptica	DESTELLO ROJO UNA VEZ	Surround 3D desactivado
ANARANJADO CONSTANTE	Encendido, la fuente es la entrada analógica	DESTELLO AZUL RÁPIDO	En espera de sincronización con dispositivo <i>Bluetooth</i>
AZUL CONSTANTE	Encendido, la fuente es el dispositivo <i>Bluetooth</i> sincronizado	DESTELLO MORADO LENTO	La SB 120 está decodificando Dolby Digital
DESTELLO VERDE / ANARANJADO / AZUL	Se ha oprimido el botón de subida de volumen o el botón de bajada de volumen de la Klipsch SB 120 o el botón de subida o bajada de volumen del subwoofer	BLANCA	Modalidad Surround 3D (luz de estado derecha)

MODALIDAD DE ESPERA

No es necesario apagar la SB 120, simplemente apague el televisor (o la caja de televisión por cable o satélite) y la SB 120 pasará automáticamente a la modalidad de espera en aproximadamente 10 minutos.

La modalidad de espera se indica con una luz de estado roja en el panel delantero. Cuando el televisor (o la caja de televisión por cable o satélite) se vuelve a encender, la SB 120 se enciende automáticamente.

COLOCACIÓN

**El televisor debe pesar menos
de 45 kg (100 lbs.)**

**La base del televisor debe medir menos
de 78 cm x 28 cm (31 plg. x 11 plg.)**

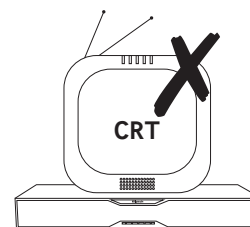
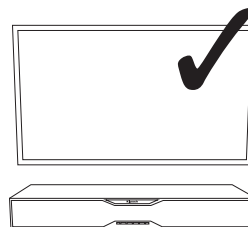
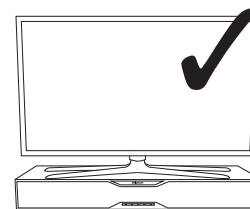
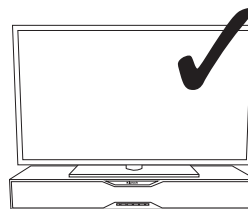
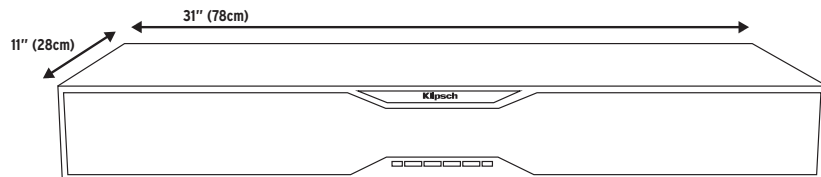

Para la ventilación, asegúrese de que la parte de atrás de la SB 120 se encuentra por lo menos a 1 plg. de la pared y que hay por lo menos 1 plg. de separación por arriba y por los lados de la SB 120.

APAGADO DE LOS ALTAVOCES DEL TELEVISOR



0

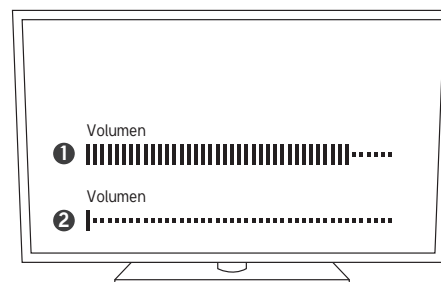

CUIDADO Y LIMPIEZA

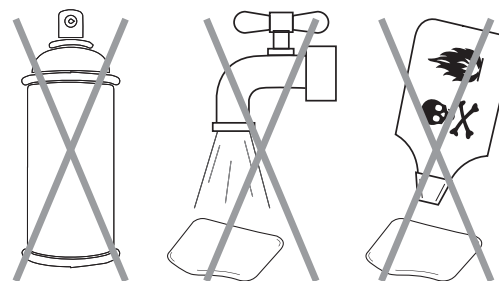
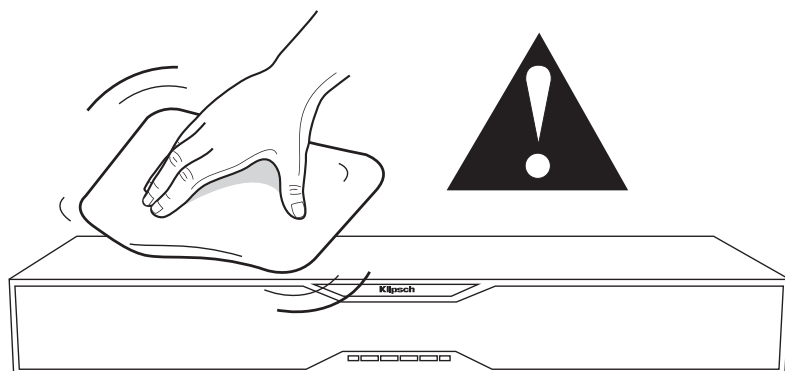

DETECCIÓN Y REPARACIÓN DE AVERÍAS

La SB 120 no se enciende

- ¿Está enchufada en un tomacorriente con corriente?
- ¿Está el interruptor de alimentación de atrás en la posición de encendido?

- **No hay sonido**
- ¿Está la Klipsch SB 120 enchufada en un tomacorriente con corriente y está el interruptor de alimentación de atrás en la posición de encendido?
- ¿Están todos los cables del televisor o de la caja de televisión por cable o satélite enchufados firmemente?
- Si se está usando el cable óptico, ¿se le retiraron las tapas de plástico transparente de los dos extremos antes de conectarlo?
- ¿Se ha subido el volumen?
- ¿Está la luz de modalidad de espera apagada (la luz de estado no es de color ROJO CONSTANTE)?
- ¿Es correcta la entrada de fuente?
- Pase el interruptor de alimentación de atrás a la posición de apagado y luego a la posición de encendido.

El control remoto del televisor o de la caja de televisión por cable o satélite no se programa

- Siga cuidadosamente todas las instrucciones de programación del control remoto.
- Vuelva a seguir cuidadosamente todas las instrucciones de programación del control remoto, pero con el control remoto original que viene con su televisor. NO es necesario volver a programar el control remoto universal o de televisión por cable o satélite.

- Programe el control remoto original del televisor para que funcione con la SB 120 (si el original es diferente), y luego use el control remoto universal sin programarlo.
- Es posible que en algunos casos tenga que repetir la programación de alguna función.
- Puede haber casos en que la SB 120 no es capaz de aprender ciertos códigos de control remoto.

El flujo de *Bluetooth* no funciona

- ¿Está el dispositivo *Bluetooth* sincronizado con la Klipsch SB 120?
- Acerque el dispositivo *Bluetooth* a la SB 120 y asegúrese de que estén sincronizados.
- Si la luz de estado destella de color ROJO mientras está intentando sincronizar, vuelva a iniciar el proceso de sincronización.

Si tiene preguntas, comuníquese con el Departamento de servicio al cliente:
En Estados Unidos: 1-866-441-8208



Fabricado bajo licencia de Dolby Laboratories. Dolby y el símbolo de la doble D son marcas comerciales registradas de Dolby Laboratories.

La marca y los logotipos de la palabra *Bluetooth*® son marcas comerciales registradas propiedad de *Bluetooth* SIG, Inc. y cualquier uso de tales marcas por parte de Klipsch Group es bajo licencia.



PACKUNGSGEHALT

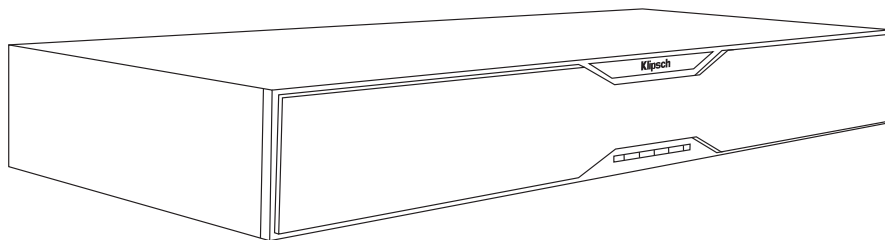

Klipsch SB 120

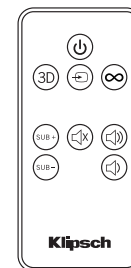

Fernbedienung

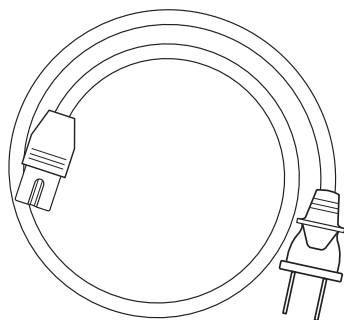

Netzkabel

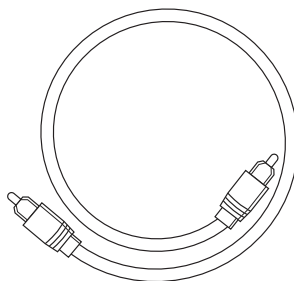

Optisches Digitalkabel

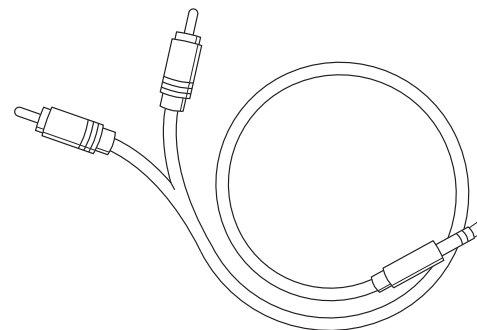

3,5 mm zu Doppel-Cinch-Kabel

OPTISCHE DIGITALVERBINDUNG

(EMPFOHLEN – FALLS FERNSEHER KEINEN OPTISCHEN AUSGANG HAT, SIEHE NÄCHSTE SEITE)

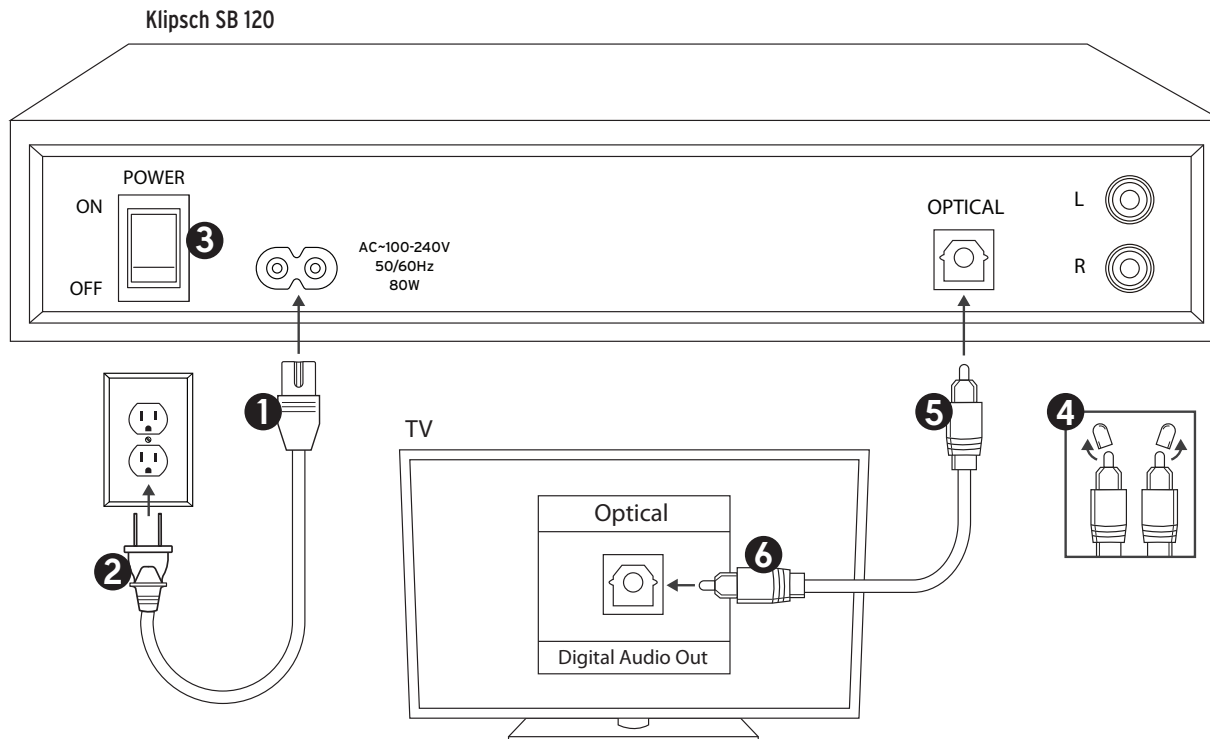

3,5 MM ZU DOPPEL-CINCH-ANALOGKABEL

(WENN FERNSEHER KEINEN KOPFHÖRER-AUSGANG HAT, SIEHE NÄCHSTE SEITE)

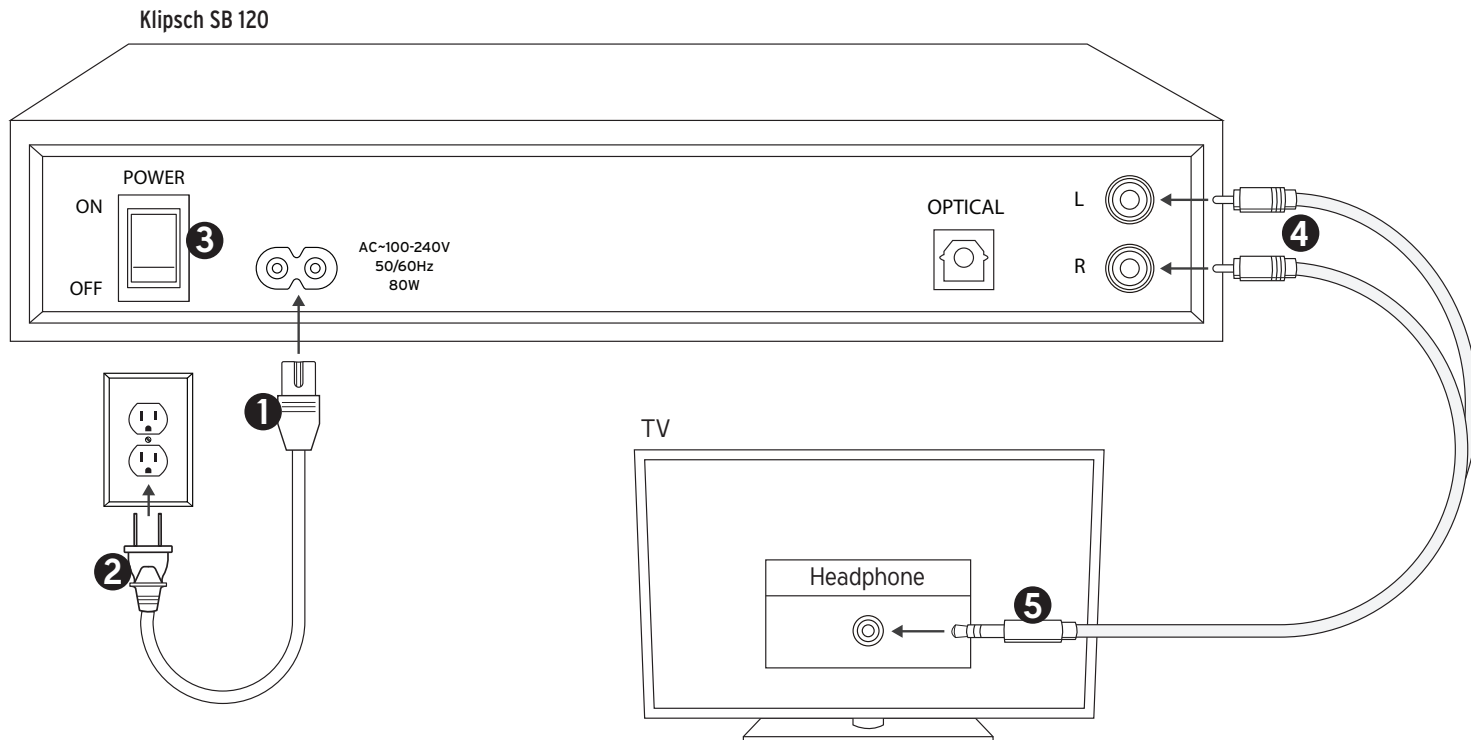

ANALOGVERBINDUNG (DOPPEL-CINCH ZU DOPPEL-CINCH)

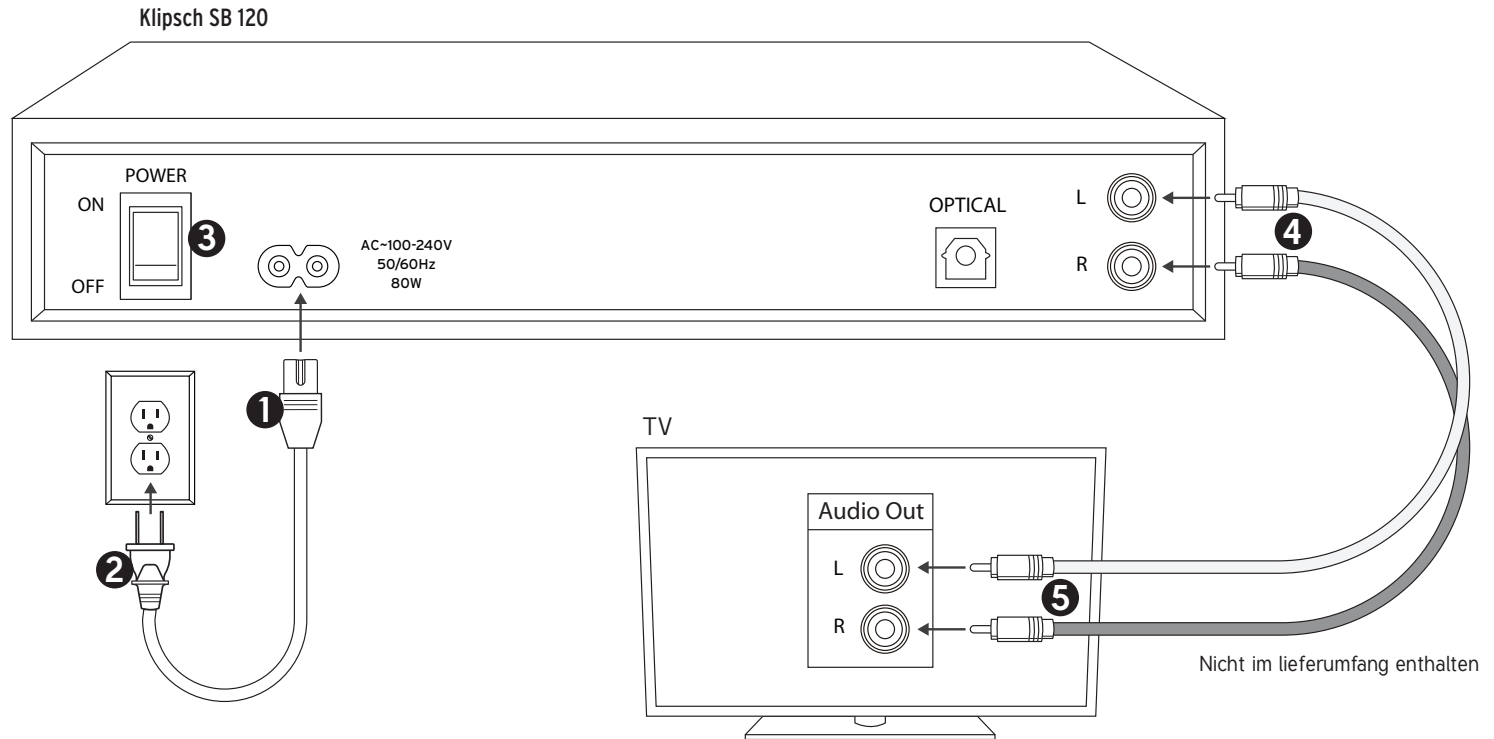

PROGRAMMIEREN DER TV-FERNBEDIENUNG

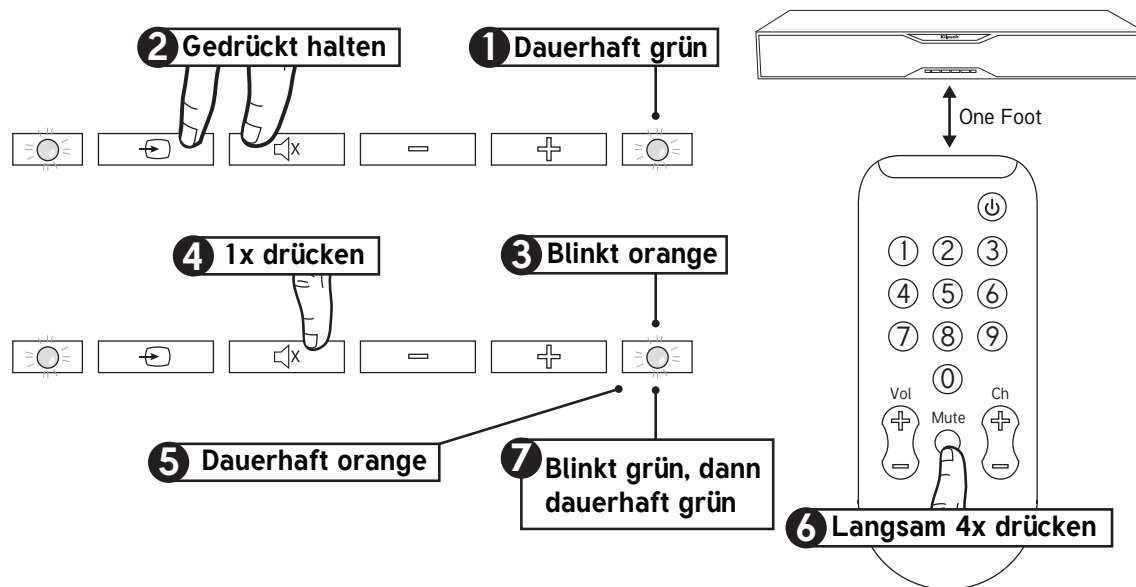

Um die Lauter- und Leiser-Tasten zu programmieren, wiederholen Sie die aufgeführten Schritte und wählen in Schritt 4 und 6 die zu programmierenden Taste.

Wenn Sie Probleme haben, eine Kabel-/Satelliten-Box oder eine Universal-Fernbedienung zu programmieren, sollten Sie versuchen, statt dessen die Fernbedienung des Fernsehers oder der Kabel-Box zu programmieren.

BLUETOOTH® DRAHTLOS-TECHNOLOGIE

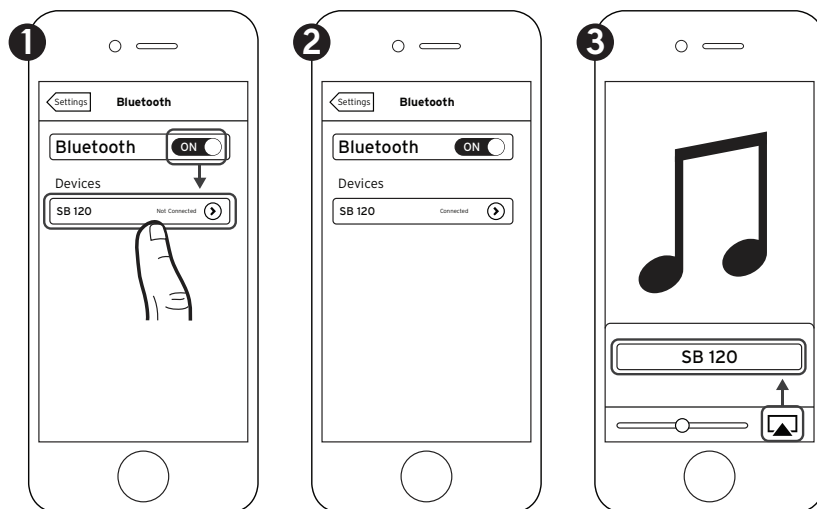

*Nur als Beispiel. Ihr Gerät kann anders aussehen

Sie können jederzeit eine Verbindung (Pairing) zu einem *Bluetooth*-Gerät herstellen, indem Sie *Bluetooth* auf Ihrem Gerät aktivieren.

Nachdem das Pairing mit Ihrem *Bluetooth*-Gerät abgeschlossen ist, wechselt die SB 120 automatisch zum *Bluetooth*-Eingang (STÄNDIG BLAUES LICHT) und Sie können Musik streamen. Wenn Sie den Eingang an der SB 120 wechseln, wird die *Bluetooth*-Verbindung automatisch beendet.

Bevor Sie das Pairing mit einem neuen *Bluetooth*-Gerät durchführen, müssen Sie das alte Pairing auf einer dieser Weisen deaktivieren:

- Halten Sie die Taste SOURCE am Bedienfeld der SB 120 3 Sekunden lang gedrückt
- Schalten Sie am verbundenen Gerät die *Bluetooth*-Funktion aus
- Drücken Sie die *Bluetooth*-Taste an der Fernbedienung der SB 120

TASTEN

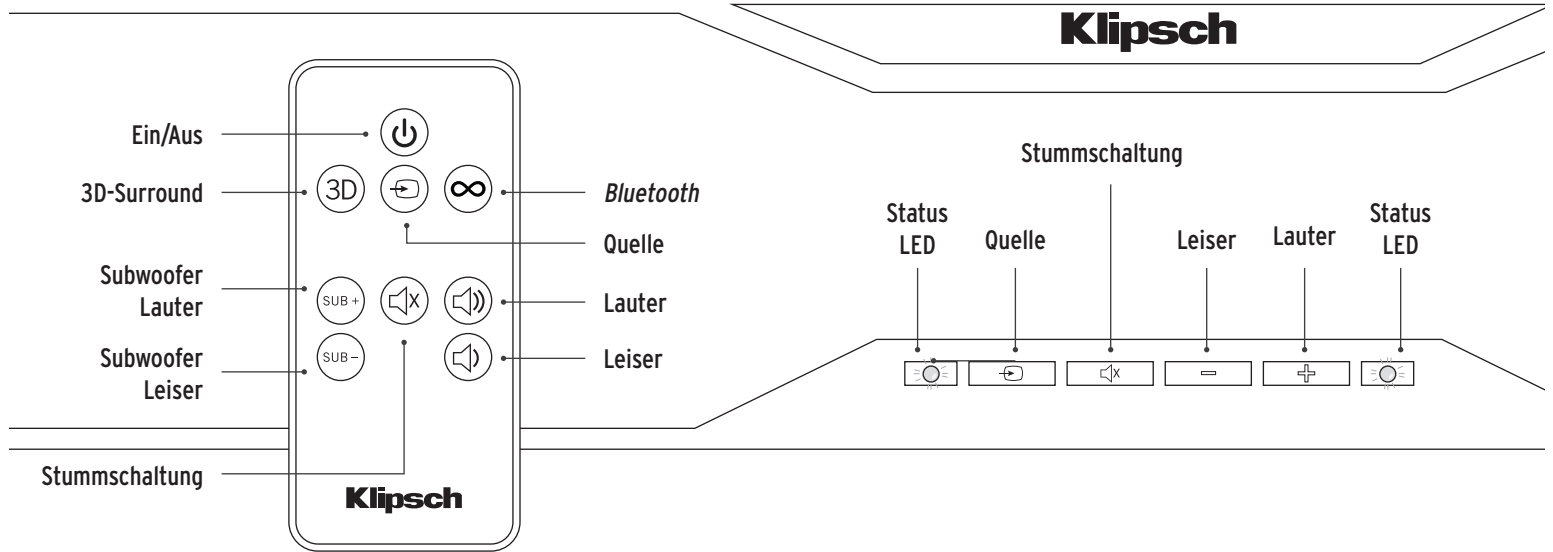

STATUSLEUCHTEN (RECHTEN STATUS-LED, WENN NICHT ANDERS ANGEGEBEN)

DAUERHAFT ROT	Ausgeschaltet (Standby-Modus)	BLINKT 1x GRÜN	3D-Surround aktiviert
DAUERHAFT GRÜN	Eingeschaltet, Quelle ist der optische Eingang	BLINKT 1x ROT	3D-Surround deaktiviert
DAUERHAFT ORANGE	Eingeschaltet, Quelle ist der Analog-Eingang	BLINKT SCHNELL BLAU	Wartet auf Pairing mit <i>Bluetooth</i> -Gerät
DAUERHAFT BLAU	Eingeschaltet, Quelle ist das verbundene <i>Bluetooth</i> -Gerät	BLINKT LANGSAM LILA	Klipsch SB 120 decodiert Dolby Digital
BLINKT GRÜN / ORANGE / BLAU	Lauter, Leiser, Subwoofer lauter oder Subwoofer leiser gedrückt	WEISS	Im 3D-Surroundmodus (rechte Statusleuchte)

STANDBY-MODUS

Sie müssen die Klipsch SB 120 nicht abschalten. Schalten Sie einfach Ihren Fernseher (oder die Satelliten-/Kabel-Box) aus, und die Power Base geht innerhalb von 10 Minuten automatisch in den Standby-Modus über.

Der Standby-Modus wird durch eine rote Status-LED an der Vorderseite angezeigt. Wenn Ihr Fernseher (oder die Satelliten-/Kabel-Box) wieder eingeschaltet wird, schaltet sich auch die Klipsch SB 120 automatisch wieder ein.

PLATZIERUNG

Der Fernseher darf maximal
45 kg wiegen

Der Sockel des Fernseher muss
kleiner als 78 cm x 28 cm sein

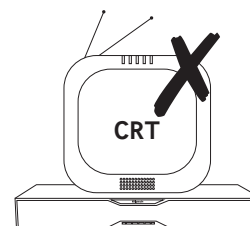
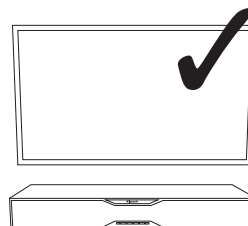
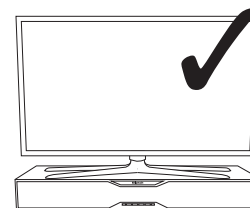
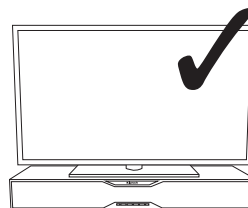
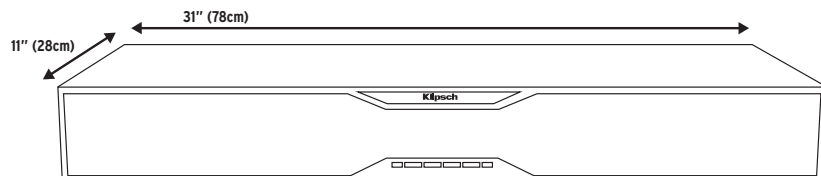

Stellen Sie sicher, dass die Rückseite der Klipsch SB 120 mindestens 2,5 cm von der Rückwand entfernt ist und dass es über und an der Seite der Klipsch SB 120 mindestens 2,5 cm Freiraum gibt, um eine gute Lüftung zu ermöglichen.

TV-LAUTSPRECHER DEAKTIVIEREN



(Empfohlen)

ODER

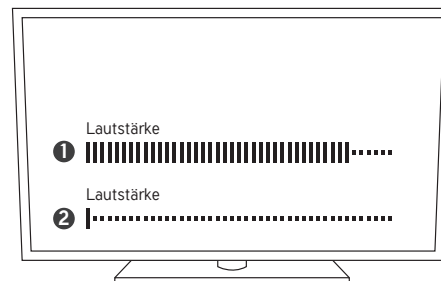

PFLEGE UND REINIGUNG

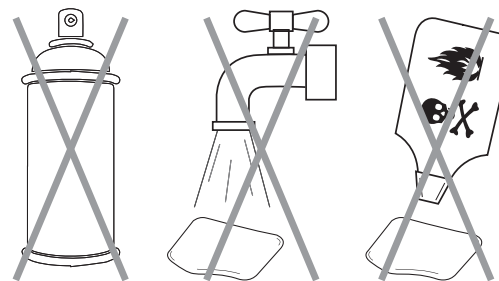
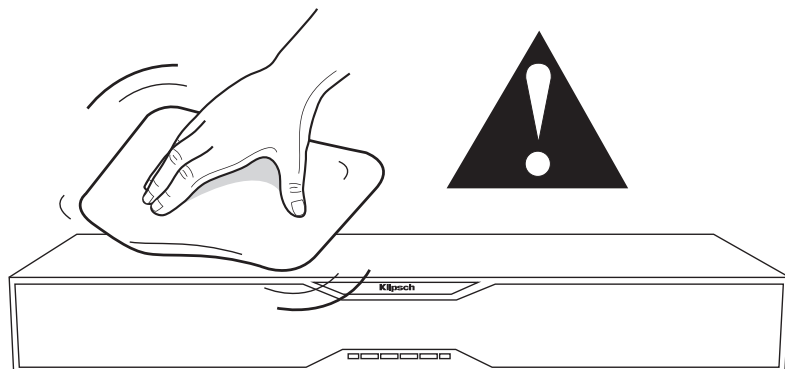

PROBLEMBESEITIGUNG

Die Klipsch SB 120 schaltet sich nicht ein

- Ist sie an eine Strom führende Steckdose angeschlossen?
- Ist der Netzschalter an der Rückseite eingeschaltet?

Kein Sound

- Ist sie an eine stromführende Steckdose angeschlossen, und ist der Netzschalter an der Rückseite eingeschaltet?
- Sind alle Verbindungen vom Fernseher bzw. der Kabel- oder Satelliten-Box fest eingesteckt?
- Wenn das optische Kabel verwendet wird, wurden vor dem Anschluss die durchsichtigen Plastikabdeckungen von beiden Enden abgenommen?
- Ist die Lautstärke hoch genug eingestellt?
- Ist der Standby-Modus deaktiviert (keine DAUERHAFT ROTE Status-LED)?
- Ist die korrekte Eingangsquelle gewählt?
- Schalten Sie den Netzschalter an der Rückseite aus und dann wieder ein.

Fernbedienung für TV/Kabel-Box/Satelliten-Box lässt sich nicht programmieren

- Folgen Sie allen Programmieranweisungen für die Fernbedienung genau.
- Wiederholen Sie sorgfältig die Programmierung der Fernbedienung, aber verwenden Sie die Original-Fernbedienung des Fernsehers. Sie müssen dann NICHT Ihre Fernbedienung für die Kabel-/Satelliten-Box oder die Universal-Fernbedienung umprogrammieren.
- Programmieren Sie die Original-Fernbedienung des Fernsehers auf die Klipsch SB 120 (falls die Original-Fernbedienung eine andere ist) und verwenden Sie dann die Universal-Fernbedienung, ohne sie zu programmieren.

- In manchen Fällen müssen Sie eventuell die Programmierung einer Funktion wiederholen.
- Es kann der Fall sein, dass die Klipsch SB 120 nicht in der Lage ist, die Codes bestimmter Fernbedienungen zu erlernen.

Das *Bluetooth*-Streaming funktioniert nicht

- Ist das *Bluetooth*-Gerät mit der Klipsch SB 120 verbunden?
- Bringen Sie Ihr *Bluetooth*-Gerät näher an die Klipsch SB 120 und stellen Sie sicher, dass ein Pairing existiert.
- Wenn beim Pairing die Status-LED ROT aufblinkt, sollten Sie das Pairing-Verfahren erneut beginnen.

Sollten Sie Fragen haben, wenden Sie sich bitte an den Kundendienst von Energy:

In den Vereinigten Staaten: 1-866-441-8208



Unter Lizenz von Dolby Laboratories hergestellt. Dolby und das Doppel-D-Symbol sind eingetragene Marken von Dolby Laboratories.

Die *Bluetooth*® Wortmarke und die Logos sind eingetragene Marken der *Bluetooth* SIG, Inc., und jegliche Nutzung dieser Marken durch Klipsch Group, Inc. erfolgt unter Lizenz.



CONTENUTO DELLA CONFEZIONE

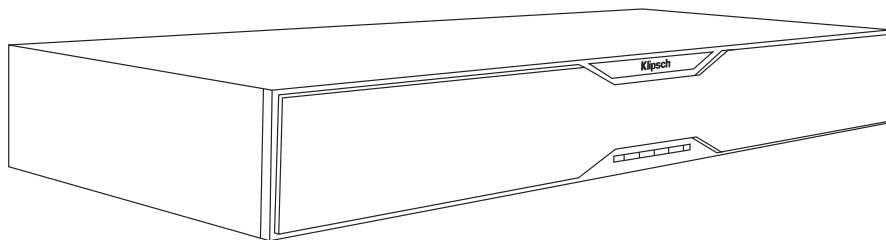

Klipsch SB 120

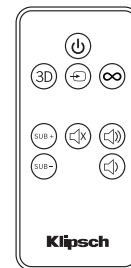

Telecomando

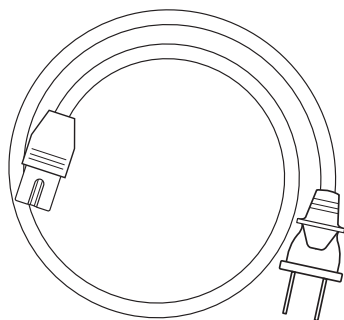

Cavo di alimentazione

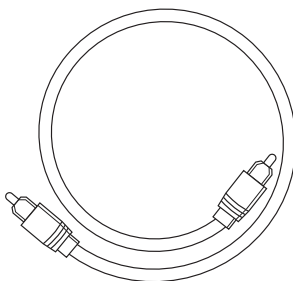

Cavo ottico digitale

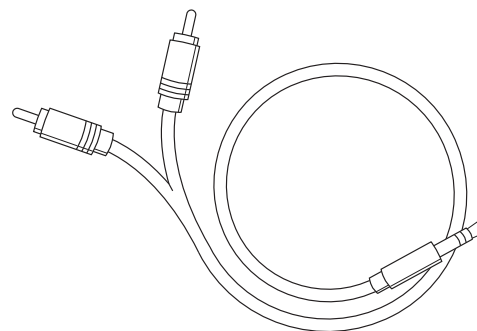

Cavo con jack da 3,5 mm a doppio jack RCA

CONNESSIONE OTTICA DIGITALE

(PREFERIBILE - SE IL TELEVISORE NON HA UN'USCITA OTTICA, VEDERE ALLA PAGINA SUCCESSIVA)

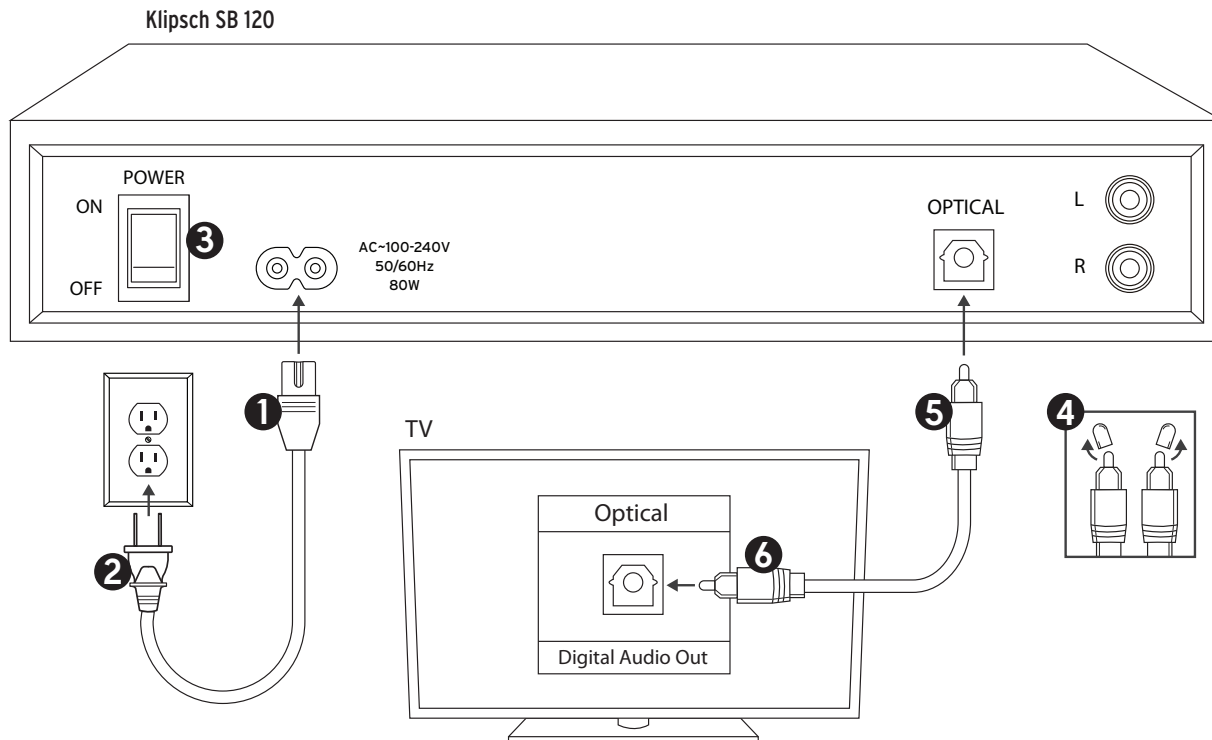

CONNESSIONE ANALOGICA CON JACK DA 3,5 MM A DOPPIO JACK RCA

(SE IL TELEVISORE NON HA UN'USCITA PER CUFFIA, VEDERE ALLA PAGINA SUCCESSIVA)

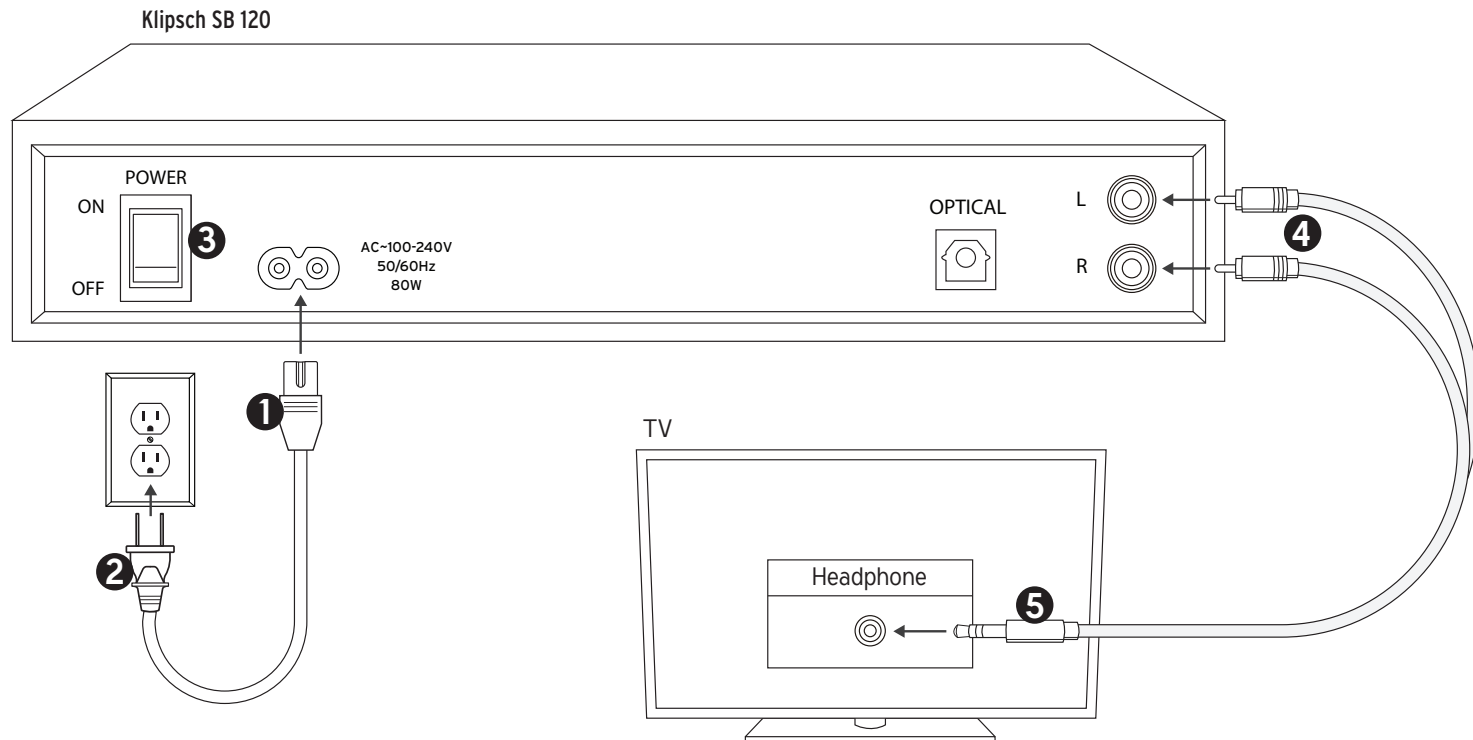

CONNESSIONE ANALOGICA DA DOPPIO JACK RCA A DOPPIO JACK RCA

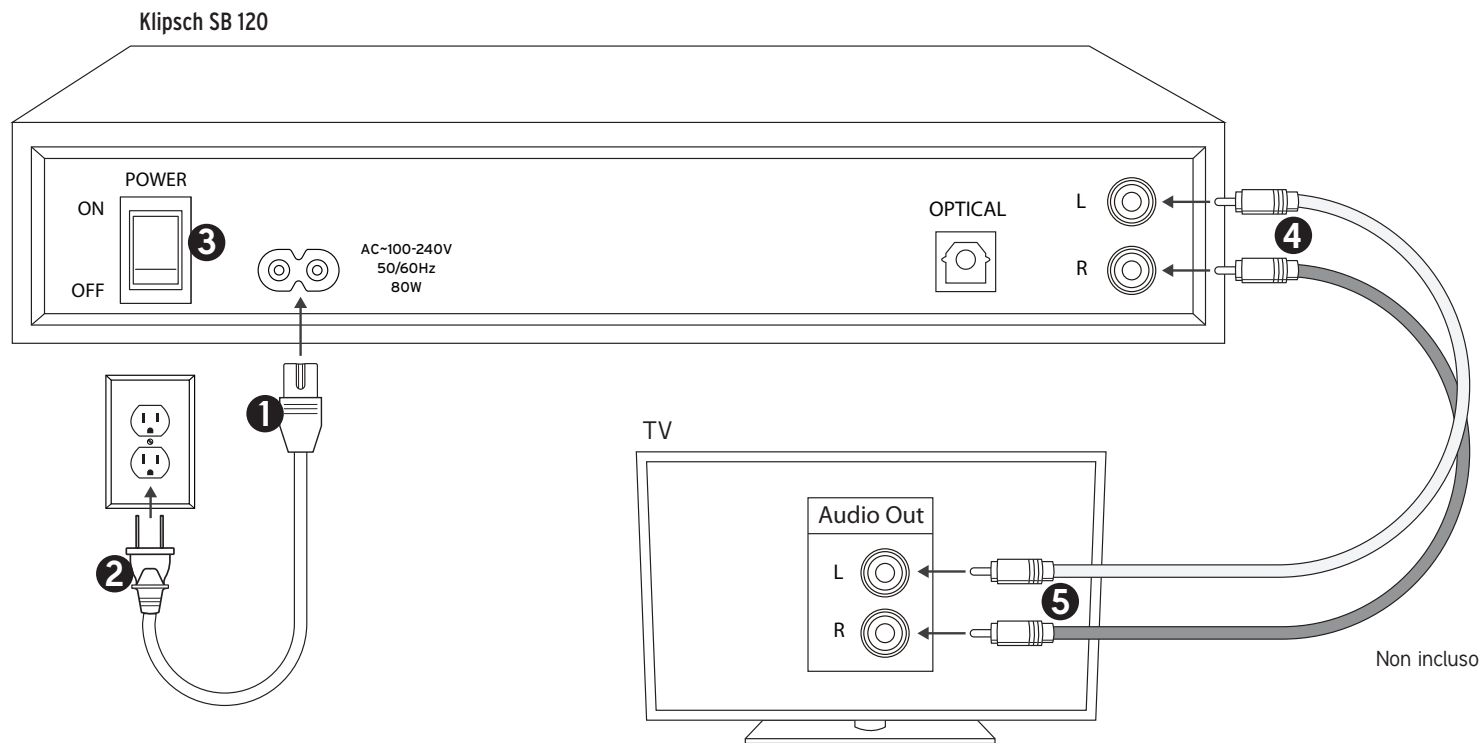

PROGRAMMAZIONE CON IL TELECOMANDO TV

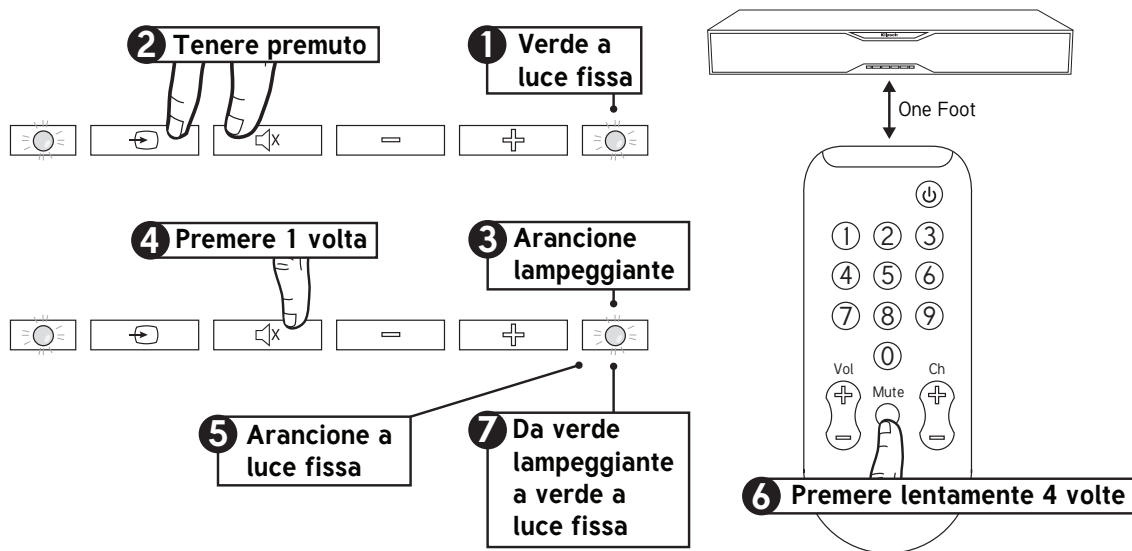

Per programmare i pulsanti di Aumento volume e Riduzione volume, ripetere i passaggi illustrati e sostituire i passaggi 4 e 6 con il pulsante che si desidera programmare.

decoder via cavo/satellitare o altro telecomando universale ma l'operazione non riesce, cercare di programmare invece il telecomando del decoder via cavo o del televisore.

Se si sta cercando di programmare il telecomando di un

TECNOLOGIA WIRELESS *BLUETOOTH*[®]

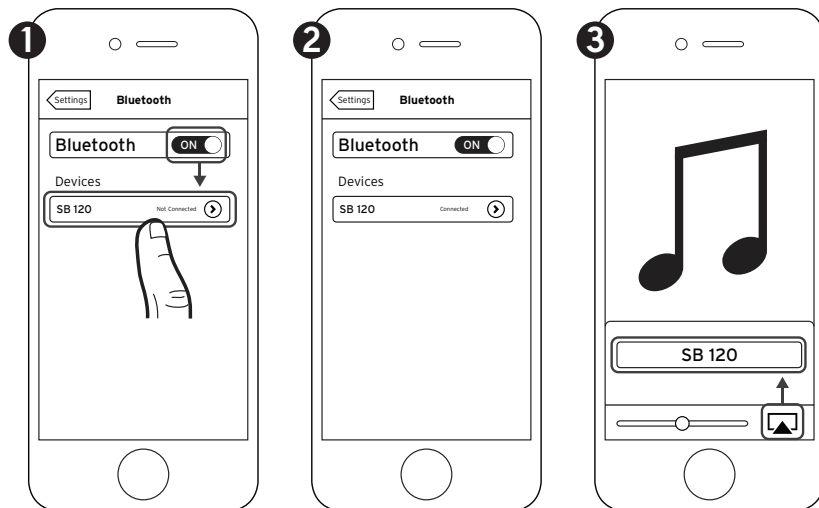

*Solo a titolo esemplificativo. Lo specifico dispositivo può essere diverso.

È possibile associare un dispositivo *Bluetooth* in qualunque momento attivando *Bluetooth* sul dispositivo stesso.

Dopo che si è associato il dispositivo *Bluetooth*, SB 120 seleziona automaticamente l'ingresso *Bluetooth* (SPIA BLU ACCESA A LUCE FISSA) e si può trasmettere in streaming la musica. Se si seleziona un altro ingresso sull'Klipsch SB 120, la connessione *Bluetooth* viene terminata automaticamente.

È necessario scollegare un dispositivo *Bluetooth* prima di associarne un altro, in uno dei seguenti modi:

- Tenendo premuto per 3 secondi il pulsante **SORGENTE** sul pannello di controllo dell'Klipsch SB 120
- Disattivando *Bluetooth* sul dispositivo associato
- Premendo il pulsante *Bluetooth* sul telecomando dell'Klipsch SB 120

PULSANTI

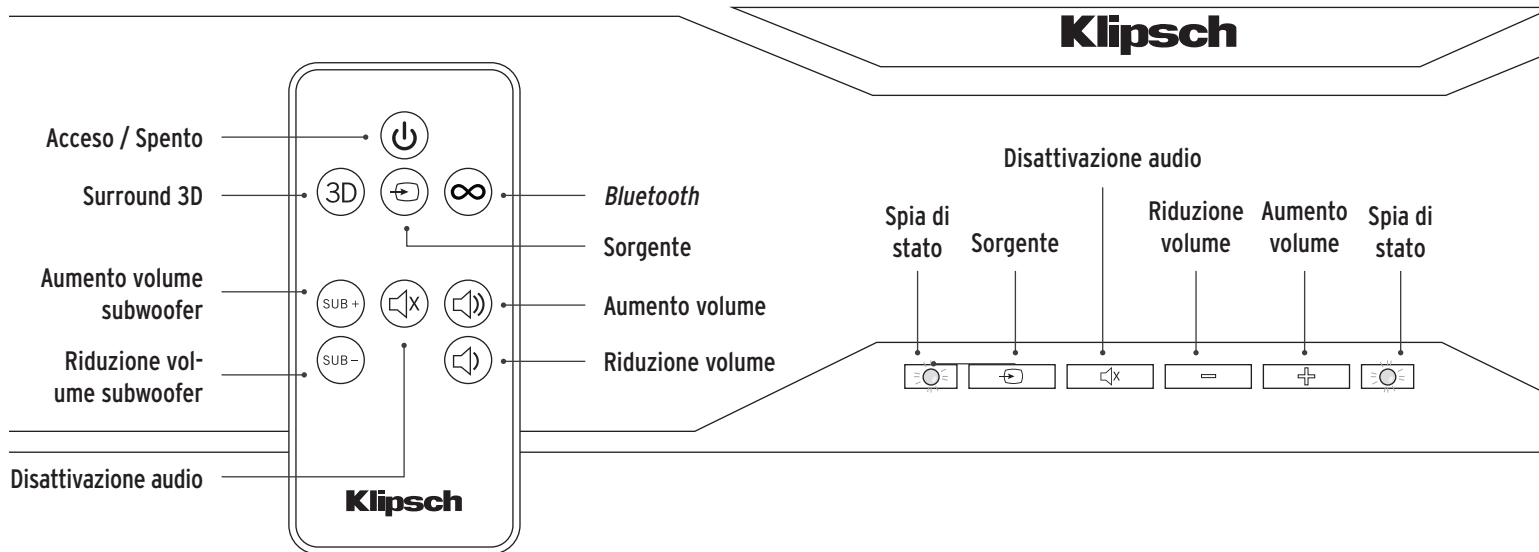

SPIE DI STATO (SPIA DELLO STATO A DESTRA SE NON INDICATO DIVERSAMENTE)

ROSSA A LUCE FISSA Spento (modalità di standby)

VERDE A LUCE FISSA Acceso; la sorgente è l'ingresso ottico

ARANCIONE A LUCE FISSA Acceso; la sorgente è l'ingresso analogico

BLU A LUCE FISSA Acceso; la sorgente è un dispositivo *Bluetooth* associato

BLU / ARANCIONE / VERDE LAMPEGGIANTE È stato premuto il pulsante di aumento o riduzione del volume oppure di aumento o riduzione di volume del subwoofer

UN LAMPEGGIO IN VERDE Surround 3D attivato

UN LAMPEGGIO IN ROSSO Surround 3D disattivato

BLU LAMPEGGIANTE VELOCEMENTE In attesa di associazione con un dispositivo *Bluetooth*

VIOLA LAMPEGGIANTE LENTAMENTE SB 120 sta decodificando un segnale digitale Dolby

BIANCO FISSO modalità Surround 3D attivata (spia di stato a sinistra)

MODALITÀ DI STANDBY

Non è necessario spegnere l'Klipsch SB 120; è sufficiente spegnere il televisore (o il decoder via cavo / satellitare) e SB 120 passa automaticamente alla modalità di standby entro circa 10 minuti.

La modalità di standby è indicata da una spia di stato rossa sul pannello anteriore. Quando si riaccende il televisore (o il decoder via cavo / satellitare), SB 120 si riaccende automaticamente.

COLLOCAZIONE

Il televisore deve pesare meno di 45 kg

**Le dimensioni della base del
televisore devono essere inferiori
a 78 cm x 28 cm**

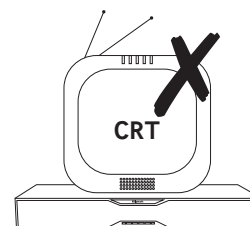
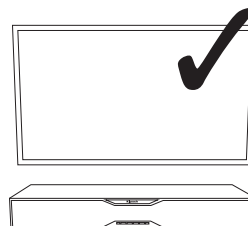
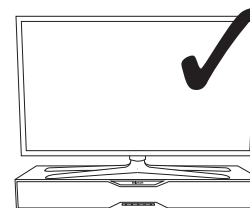
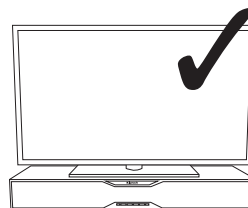
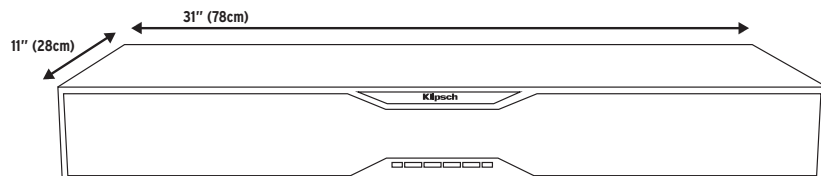

Accertarsi che la parte posteriore dell'Klipsch SB 120 si trovi a una distanza di almeno 2,5 centimetri dalla parete posteriore e che vi sia una distanza libera di almeno 2,5 centimetri intorno alle parti superiore e laterali dell'Klipsch SB 120 per la ventilazione.

SPEGNIMENTO DEGLI ALTOPARLANTI DEL TELEVISORE



(Consigliato)

OPPURE

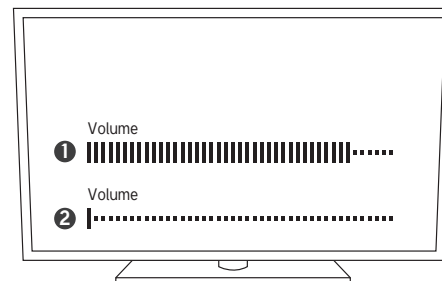

CURA E PULIZIA

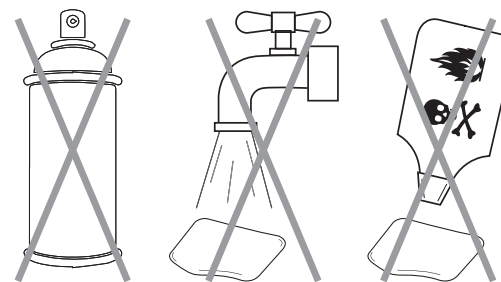
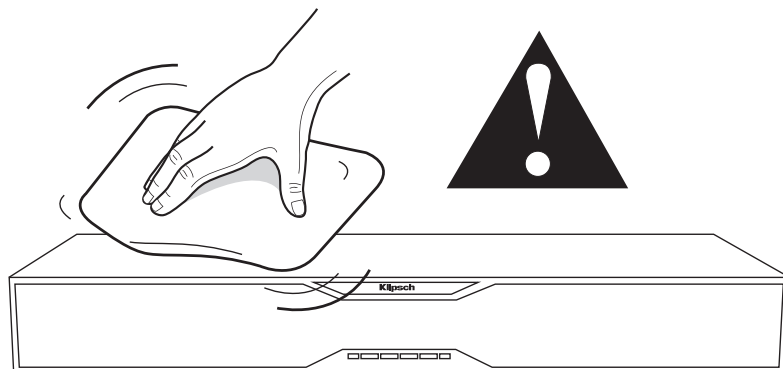

GUIDA ALLA SOLUZIONE DEI PROBLEMI

L'Klipsch SB 120 non si accende

- È collegato a una presa elettrica sotto tensione?
- L'interruttore di alimentazione, sul pannello posteriore, è nella posizione 'Acceso'?
- **Nessun suono**
- È collegato a una presa elettrica sotto tensione e l'interruttore di alimentazione, sul pannello posteriore, è nella posizione 'Acceso'?
- Tutti i cavi uscenti dal televisore/decoder via cavo / satellitare sono inseriti bene?
- Se si usa il cavo ottico, prima della connessione sono stati rimossi i tappi di plastica trasparente da entrambe le estremità?
- Il volume è stato aumentato?
- La modalità di standby è disattivata (nessuna spia di stato ROSSA A LUCE FISSA)?
- L'ingresso di sorgente è corretto?
- Portare l'interruttore di alimentazione, sul pannello posteriore, nella posizione 'Spento' e quindi di nuovo su 'Acceso'.

Il telecomando del televisore/decoder via cavo / satellitare non programma

- Seguire con attenzione tutte le istruzioni per la programmazione del telecomando.
- Seguire di nuovo con attenzione tutte le istruzioni per la programmazione del telecomando, ma usare il telecomando originale fornito

con il televisore. **NON** è necessario quindi riprogrammare con il telecomando

universale o del decoder via cavo/satellitare.

- Programmare il telecomando originale del televisore sull'Klipsch SB 120 (se quello originale è uno diverso), quindi usare il telecomando universale senza programmarlo.
- In alcuni casi può essere necessario ripetere la programmazione di una funzione.
- In alcuni casi, l'Klipsch SB 120 potrebbe non essere in grado di memorizzare determinati codici del telecomando.

La trasmissione in streaming *Bluetooth* non funziona

- Il dispositivo *Bluetooth* è associato all'Klipsch SB 120?
- Avvicinare il dispositivo *Bluetooth* all'Klipsch SB 120 e accertarsi che sia associato.
- Se la spia di stato lampeggia in ROSSO mentre si cerca di associare il dispositivo, ricominciare da capo la procedura di associazione.

Per eventuali domande contattare il servizio clienti Energy:

Negli Stati Uniti: 1-866-441-8208



Fabbricato su licenza di Dolby Laboratories. Dolby e il simbolo della doppia D sono marchi registrati di Dolby Laboratories.

Il logo e la parola *Bluetooth*® sono marchi registrati di *Bluetooth* SIG, Inc. e qualunque loro uso da parte di Klipsch Group, Inc. è su licenza.



O QUE ESTÁ INCLUÍDO

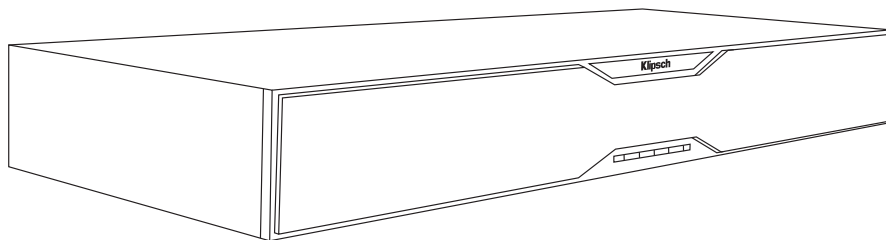

Klipsch SB 120

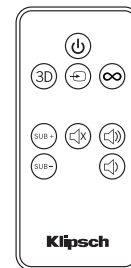

Controle remoto

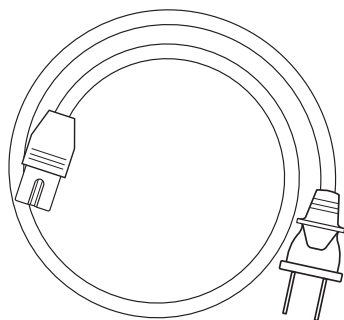

Cabo de alimentação de CA

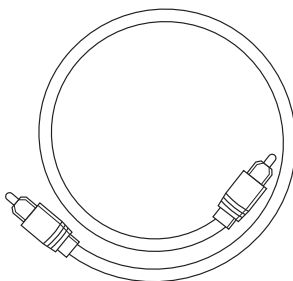

Cabo óptico digital

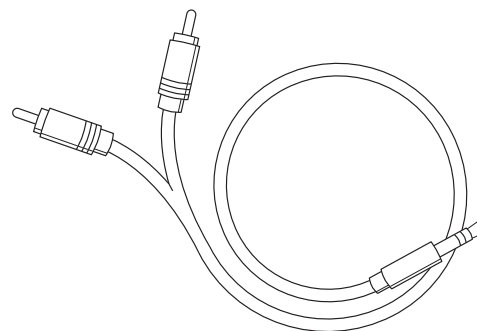

Cabo para conexão de 3,5 mm para RCA duplo

CONEXÃO ÓTICA DIGITAL

(PREFERENCIAL - SE A TV NÃO TIVER SAÍDA ÓTICA, CONSULTE A PRÓXIMA PÁGINA)

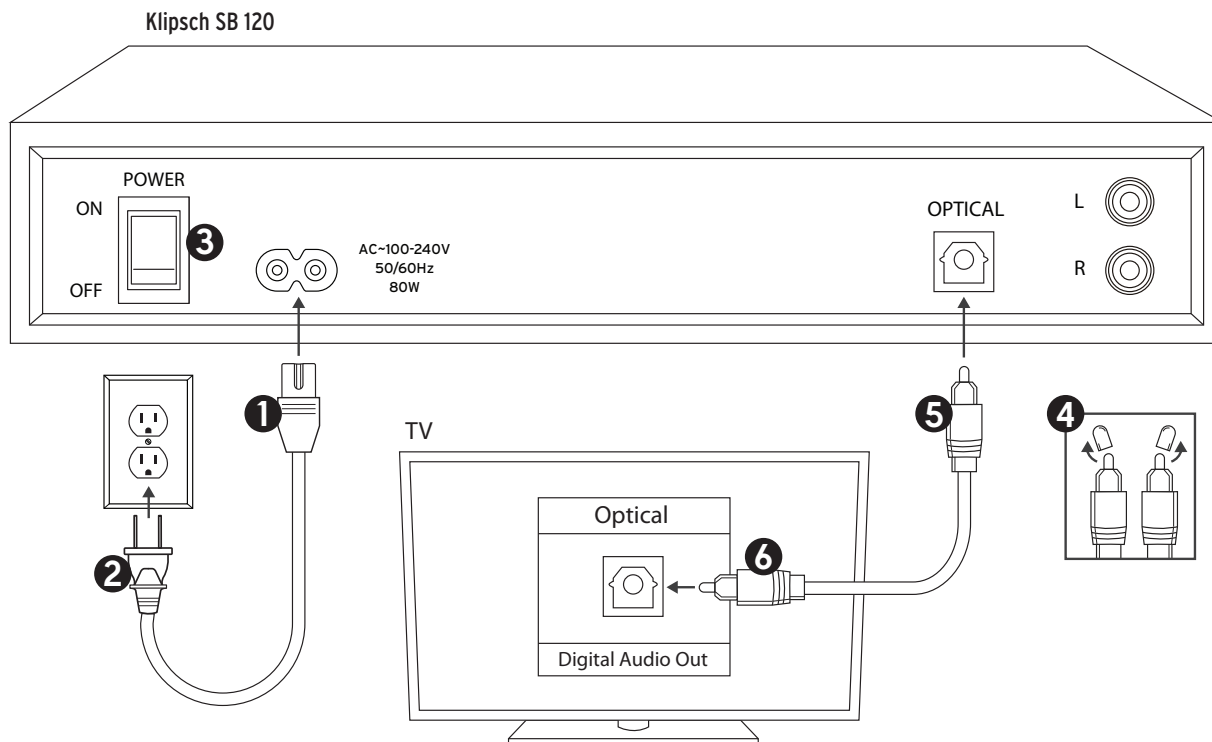

CONEXÃO ANALÓGICA DE 3,5 MM PARA RCA DUPLO

(SE A TV NÃO TIVER SAÍDA PARA FONES DE OUVIDO, CONSULTE A PRÓXIMA PÁGINA)

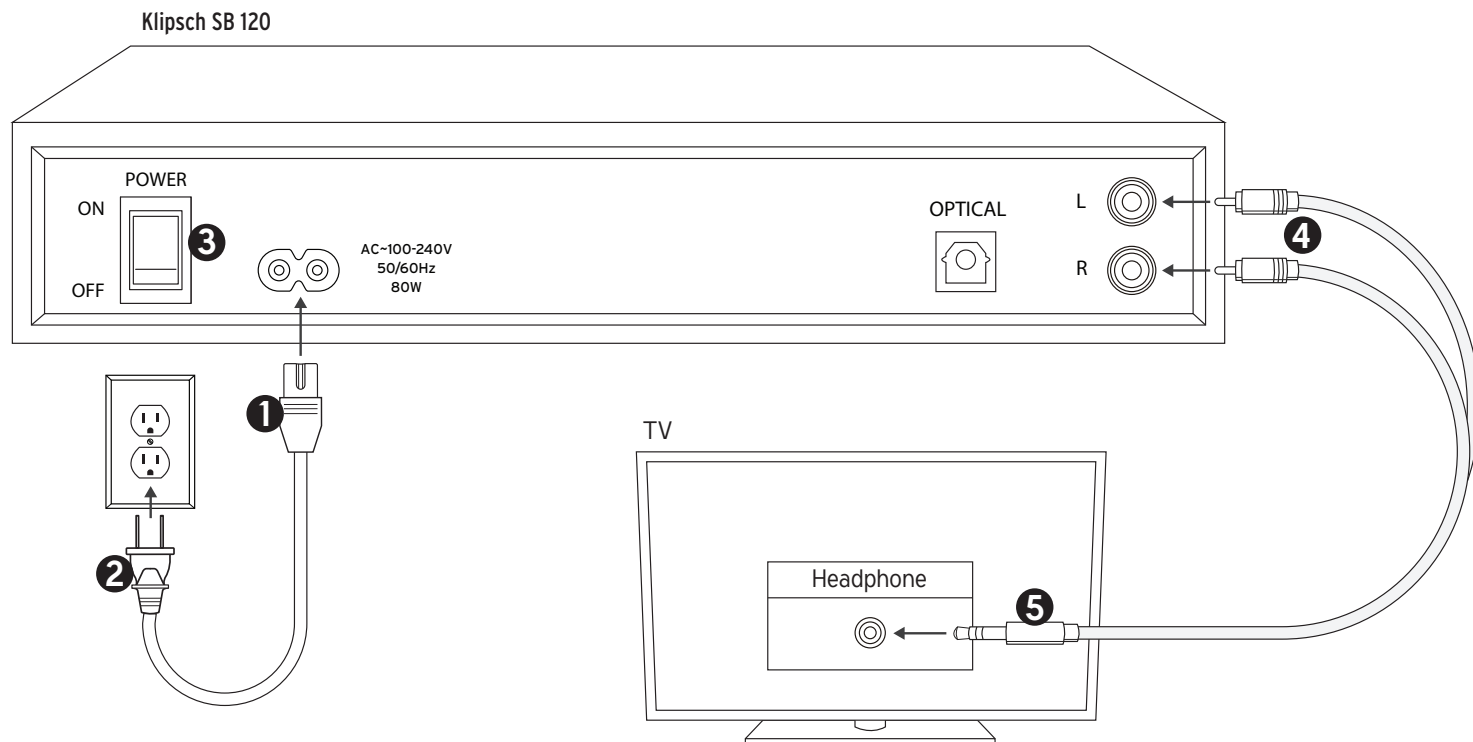

CONEXÃO ANALÓGICA DE RCA DUPLO PARA RCA DUPLO

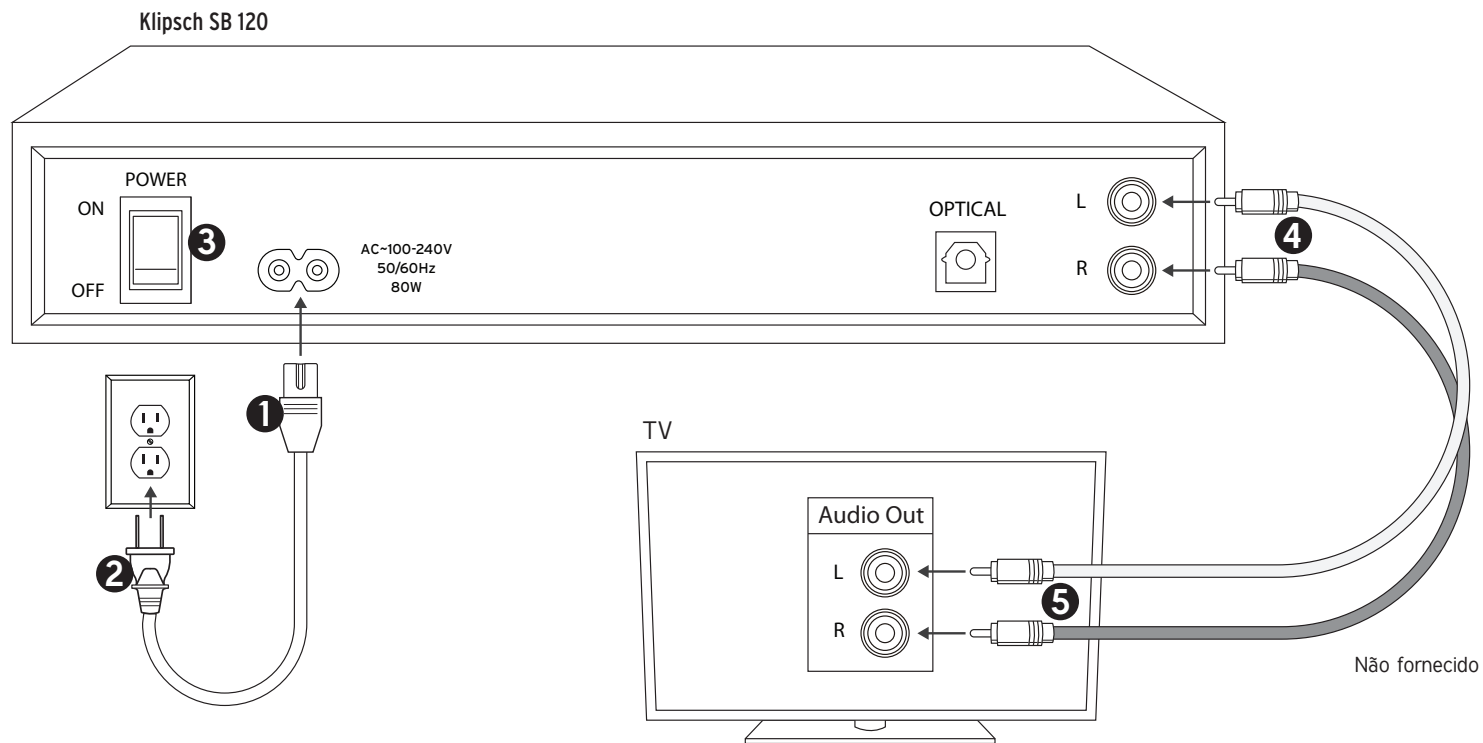

PROGRAMAÇÃO DO CONTROLE REMOTO DA TV

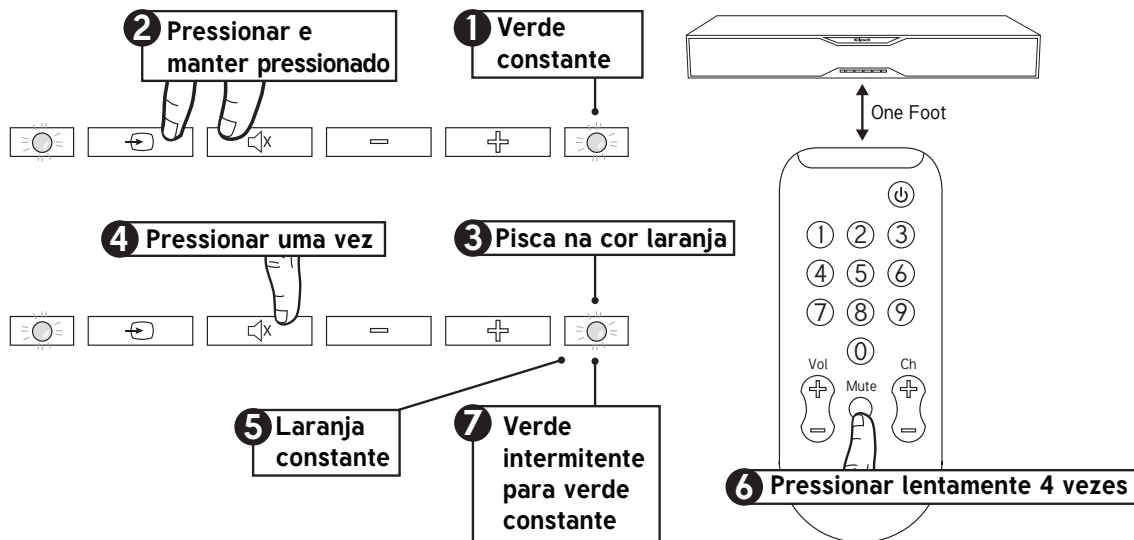

Para programar os botões de aumentar/diminuir o volume, repita os passos indicados e substitua as etapas 4 e 6 com o botão que deseja programar.

Se não estiver tendo sucesso em programar o controle remoto de um receptor de TV a cabo/satélite ou outro controle remoto universal, tente programar o controle remoto da TV ou do receptor de sinal a cabo.

TECNOLOGIA SEM FIO *BLUETOOTH*[®]

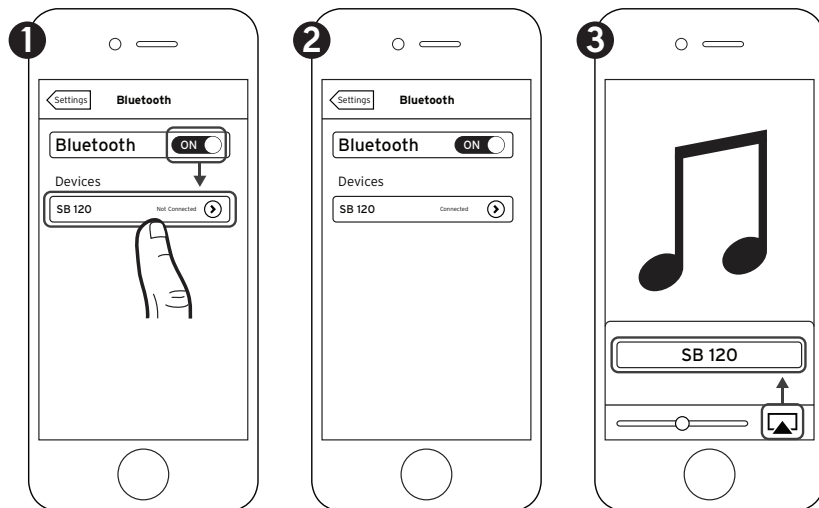

*Apenas para exemplo. O dispositivo pode ser diferente.

É possível emparelhar um dispositivo *Bluetooth* a qualquer momento ativando o *Bluetooth* no dispositivo.

Depois que o dispositivo *Bluetooth* estiver emparelhado, a SB 120 mudará automaticamente para a entrada *Bluetooth* (LUZ AZUL CONSTANTE), o que permitirá a reprodução de músicas. Se a entrada for alterada na SB 120, a conexão *Bluetooth* será automaticamente encerrada.

É necessário desconectar um dispositivo *Bluetooth* antes de emparelhar outro. Para isso:

- Pressione e mantenha pressionado por 3 segundos o botão **SOURCE** no painel de controle da SB 120
- Desative o *Bluetooth* no dispositivo emparelhado
- Pressione o botão *Bluetooth* no controle remoto da Klipsch SB 120

BOTÕES

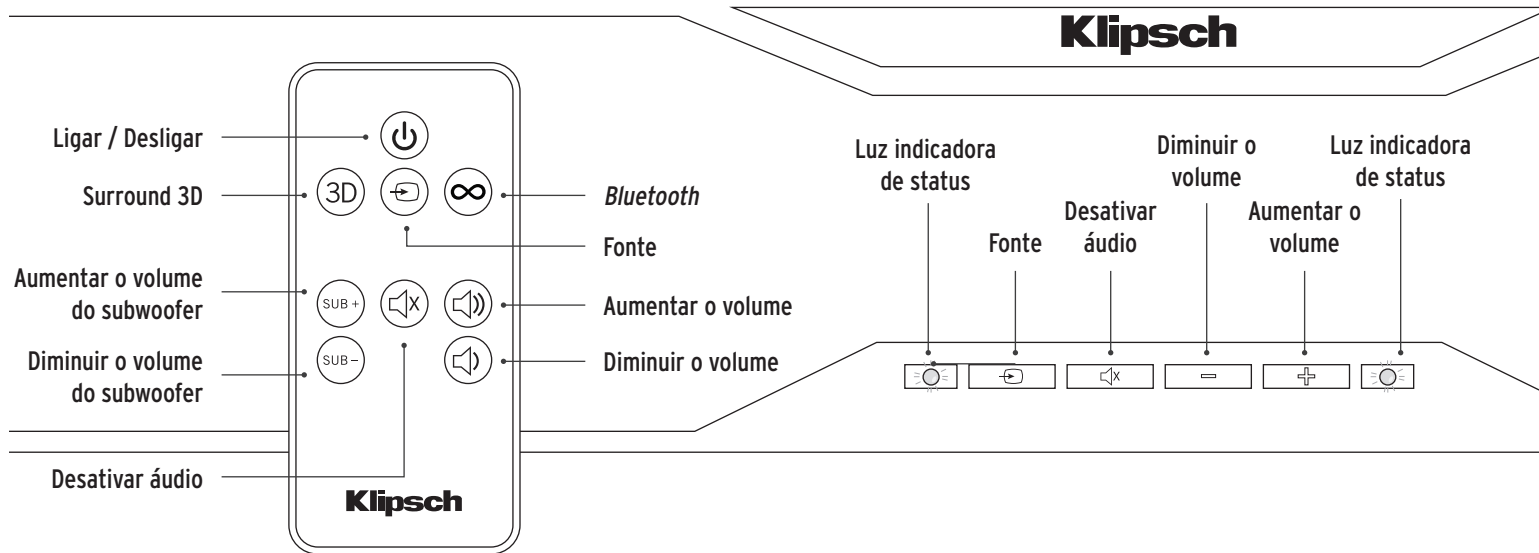

LUZES INDICADORAS DE STATUS (LUZ DE STATUS DO DIREITO, SALVO INDICAÇÃO)

VERMELHO CONSTANTE	Desligado (modo de espera)	PISCA EM VERDE UMA VEZ	Surround 3D ligado
VERDE CONSTANTE	Ligado, a fonte é a entrada ótica	PISCA EM VERMELHO UMA VEZ	Surround 3D desligado
LARANJA CONSTANTE	Ligado, a fonte é a entrada analógica	PISCA RAPIDAMENTE EM AZUL	Aguardando emparelhamento com o dispositivo <i>Bluetooth</i>
AZUL CONSTANTE	Ligado, a fonte é o dispositivo <i>Bluetooth</i> emparelhado	PISCA LENTAMENTE EM ROXO	A SB 120 está decodificando o sinal Dolby Digital
PISCA EM VERDE / LARANJA / AZUL	Botão de aumentar o volume, diminuir o volume, aumentar o volume do subwoofer ou diminuir o volume do subwoofer pressionado	BRANCA	No modo surround 3D (luz de status direita)

MODO DE ESPERA

Não é necessário desligar a SB 120, basta desligar a TV (ou o receptor de satélite/cabo) e a SB 120 entrará automaticamente no modo de espera em cerca de 10 minutos.

O modo de espera é identificado por uma luz indicadora de status vermelha no painel frontal. Quando a TV (ou o receptor de satélite/cabo) voltar a ser ligada, a SB 120 ligará automaticamente.

POSICIONAMENTO

A TV deve pesar menos
de 45 kg (100 lbs)

A base da TV deve ser menor que
78 cm x 28 cm (31" x 11")

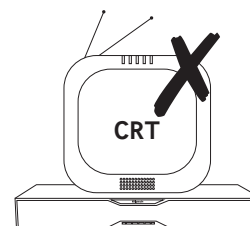
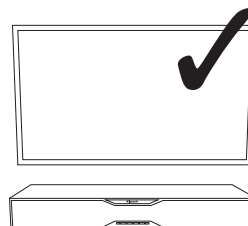
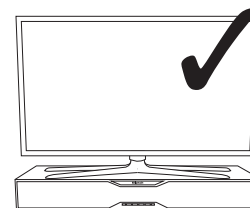
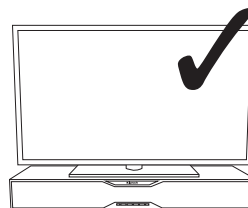
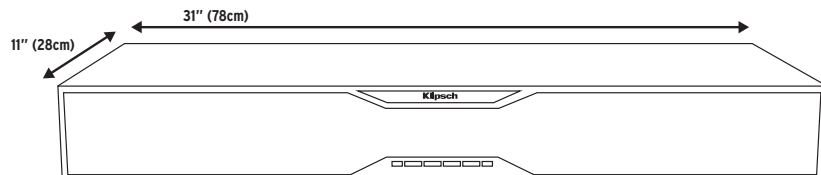

Certifique-se de que a parte traseira da SB 120 esteja, no mínimo, a 2,5 cm de distância da parede e que haja pelo menos 2,5 cm de espaço ao redor da parte superior e das laterais da SB 120 para ventilação.

DESLIGUE OS ALTO-FALANTES DA TV

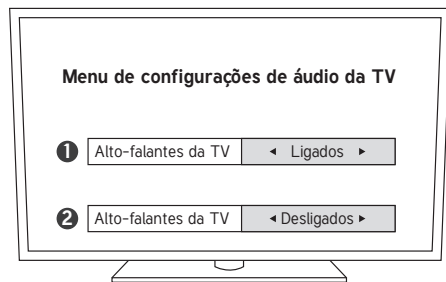

(Recomendado)

OU

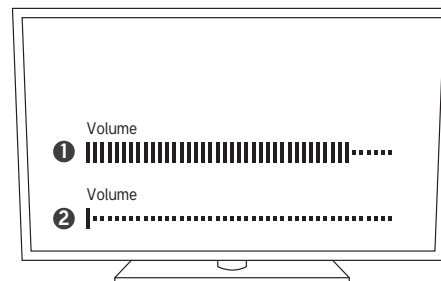

CUIDADOS E LIMPEZA

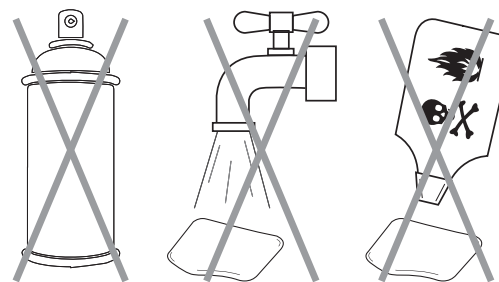
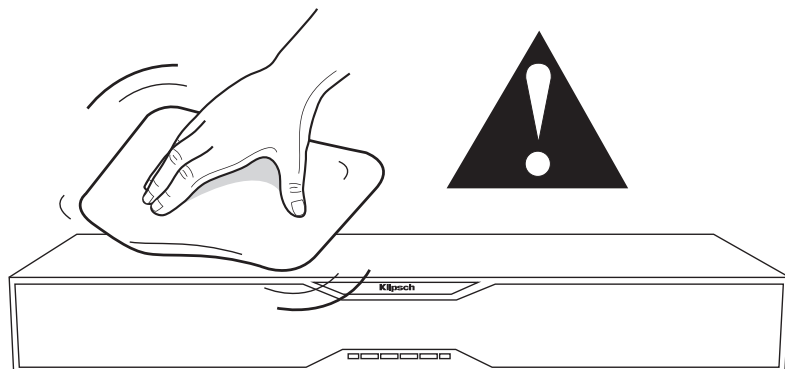

SOLUÇÃO DE PROBLEMAS

- A SB 120 não liga
- A unidade está ligada em uma tomada “energizada”?
- A chave liga/desliga no painel traseiro está ligada?

Não há som

- A unidade está ligada em uma tomada “energizada” e a chave liga/desliga no painel traseiro está ligada?
- Todos os cabos da TV/receptor de TV a cabo ou satélite estão bem conectados?
- Se o cabo ótico estiver sendo utilizado, as coberturas de plástico transparentes foram removidas das duas extremidades antes da conexão?
- O volume está alto?
- O modo de espera está desligado (sem luz indicadora de status VERMELHA CONSTANTE)?
- A fonte de entrada está correta?
- Desligue a chave liga/desliga do painel traseiro e, em seguida, ligue-a novamente.

Não é possível programar o controle remoto da TV/receptor de TV a cabo/receptor de TV por satélite

- Siga com atenção todas as instruções de programação do controle remoto.
- Faça com atenção a programação do controle remoto novamente, mas use o controle remoto original fornecido com a TV. Assim NÃO é necessário reprogramar o controle remoto universal/do receptor de TV a cabo/satélite.

- Programe as funções da SB 120 no controle remoto original da TV (se o original for diferente), em seguida, use o controle remoto universal sem programá-lo.
- Em alguns casos, pode ser necessário repetir a programação de uma ou outra função.
- Pode ser que a SB 120 não consiga aprender certos códigos do controle remoto.

A transmissão por *Bluetooth* não funciona

- O dispositivo *Bluetooth* está emparelhado com a SB 120?
- Aproxime o dispositivo *Bluetooth* da Klipsch SB 120 e certifique-se de que esteja emparelhado.
- Se a luz indicadora de status piscar na cor VERMELHA durante a tentativa de emparelhamento, reinicie o processo de emparelhamento.

Em caso de dúvidas, entre em contato com o Serviço de Atendimento ao Cliente da Energy:

Nos Estados Unidos: 1-866-441-8208



Fabricado sob licença da Dolby Laboratories. Dolby e o símbolo do D duplo são marcas registradas da Dolby Laboratories.

A marca e os logotipos com a palavra *Bluetooth*® são marcas comerciais registradas de propriedade da *Bluetooth SIG, Inc.* e qualquer uso de tais marcas pela Klipsch Group, Inc. é feito mediante licença.



产品组件

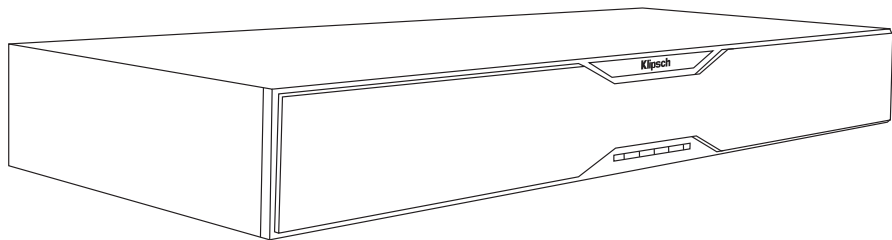

Klipsch SB 120

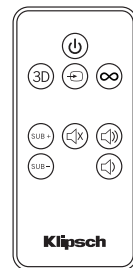

遥控器

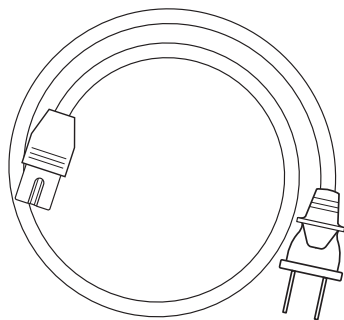

交流电源线

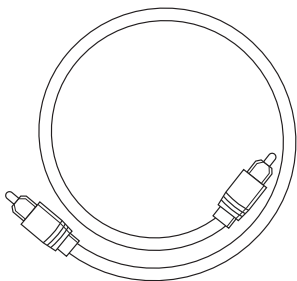

数字光纤电缆

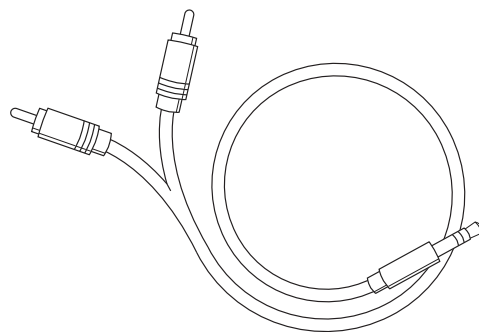

3.5mm 转双 RCA 电缆

数字光纤连接（首选，如果电视机不带光纤输出端口，请参见下一页）

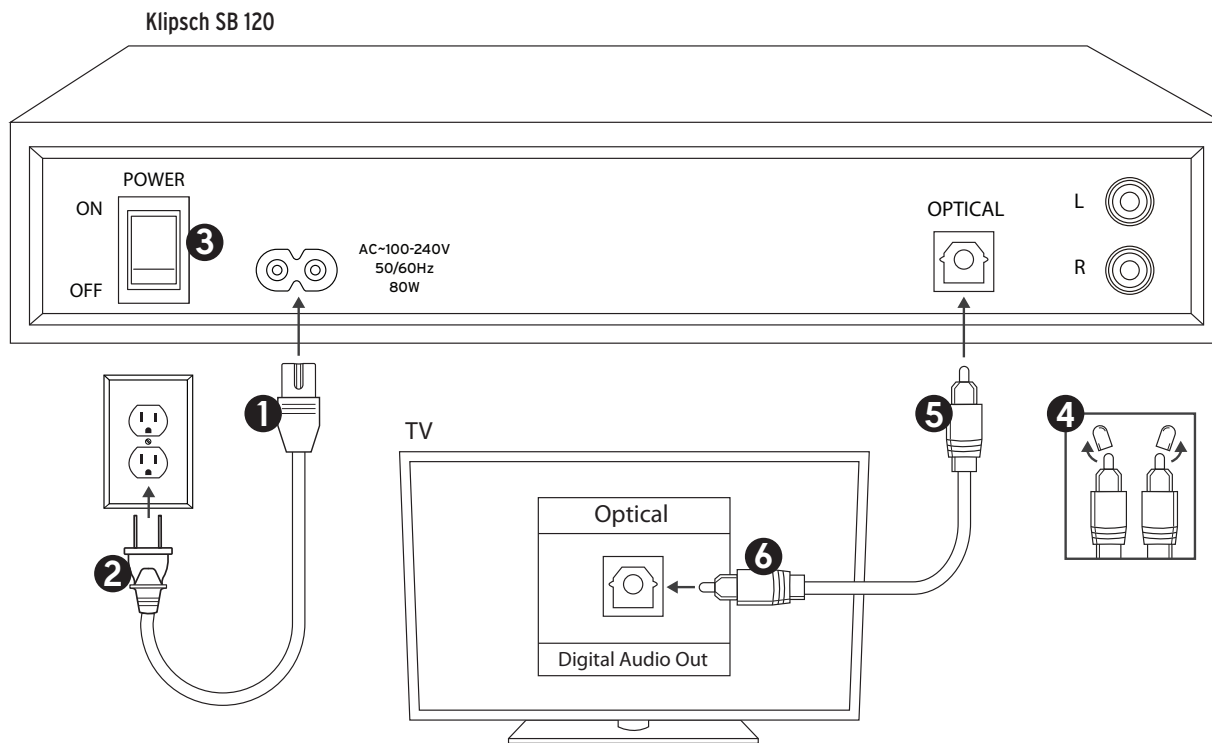

3.5MM 转双 RCA 模拟连接（如果电视机不带耳机输出端口，请参见下一页）

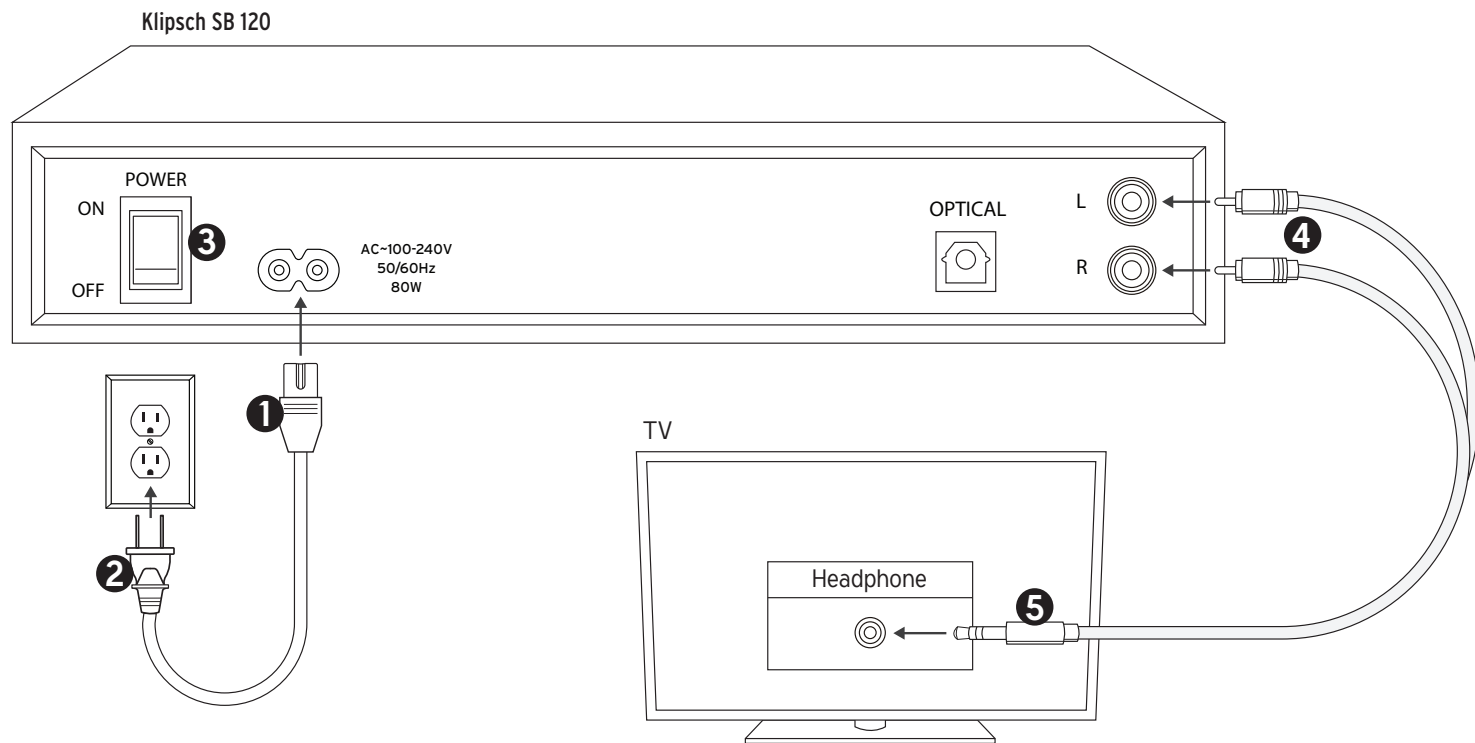

双 RCA 转双 RCA 模拟连接

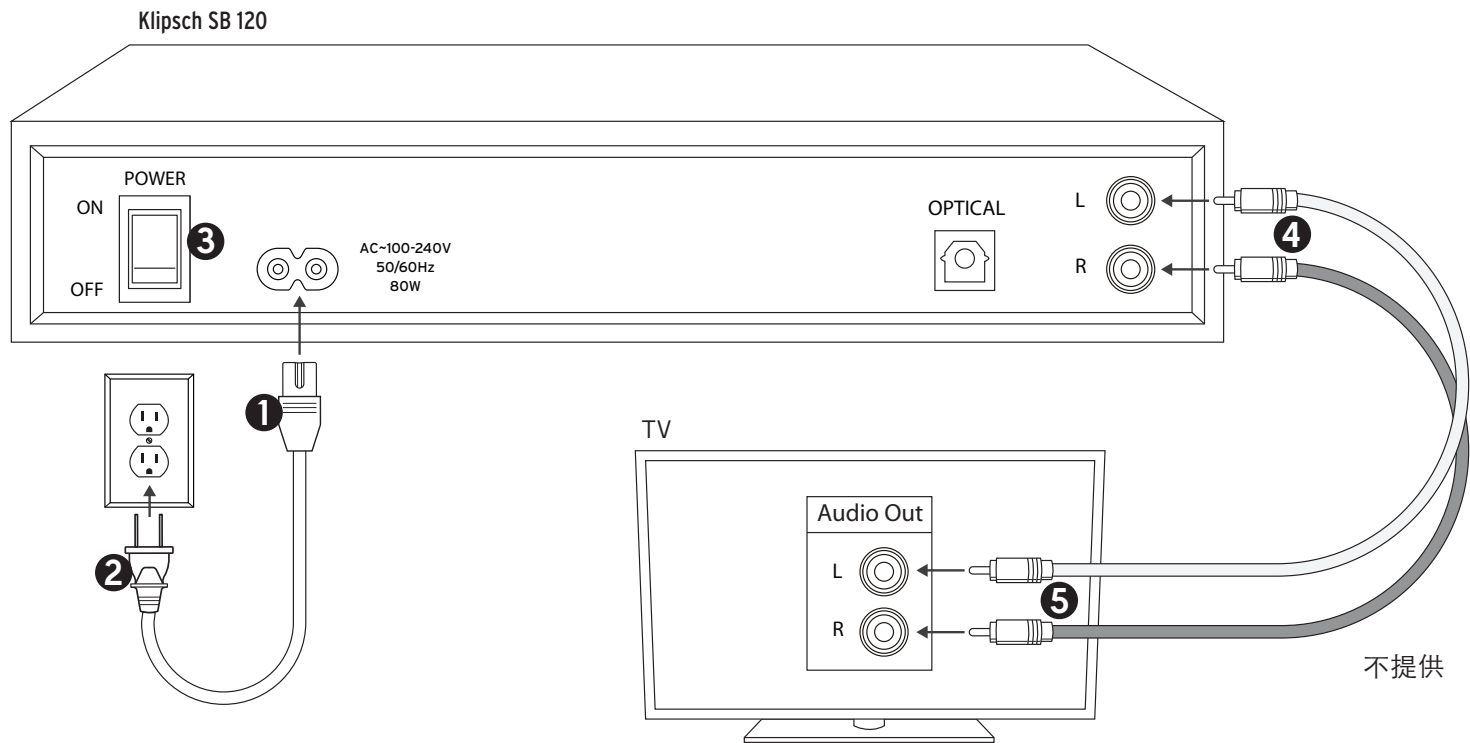

电视机遥控器编程

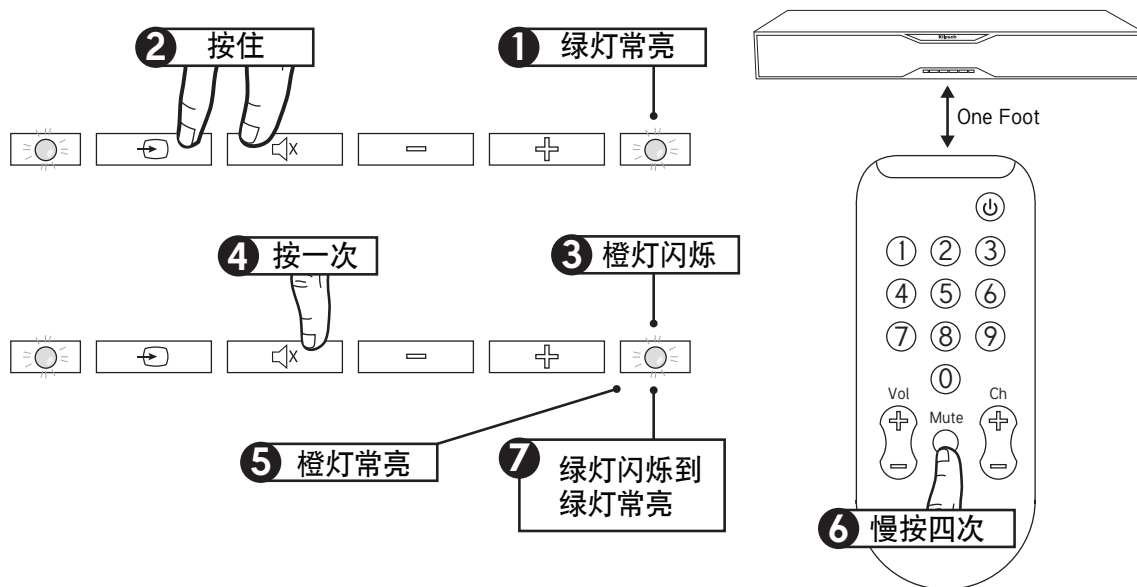

要对音量增大和音量减小按钮编程，请重复以上步骤，并将第 4 步和第 6 步中按下的按钮替换为要编程的按钮。

如果对有线/卫星电视机顶盒遥控器或其它通用遥控器的编程失败，请尝试对电视遥控器或有线电视电视机顶盒遥控器进行编程。

蓝牙无线技术

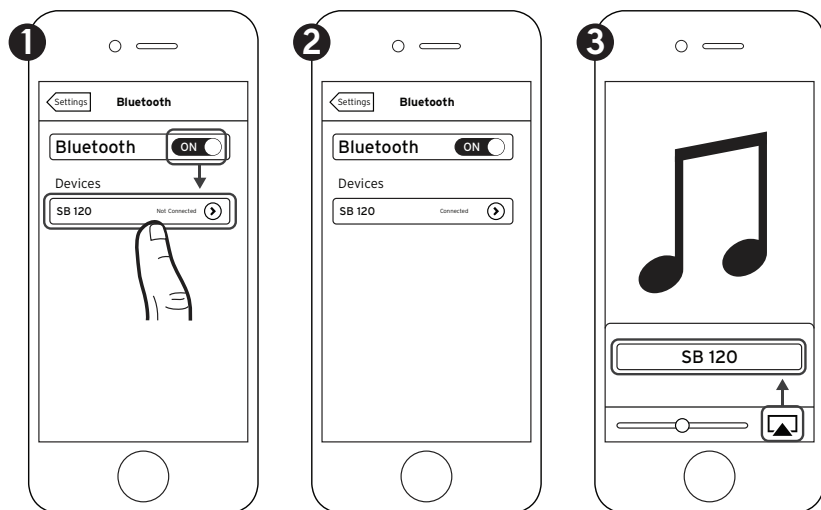

*仅为示例。实际设备可能有所不同

可随时激活蓝牙设备上的蓝牙功能与 SB 120 配对。

蓝牙设备配对后，SB 120 将自动切换至蓝牙输入（蓝灯常亮），此时可向 Klipsch SB 120 发送音乐。在 Klipsch SB 120 上切换输入模式时，蓝牙连接会自动中断。

要与另一蓝牙设备配对，必须先断开当前配对的蓝牙设备。可通过以下任一方法断开蓝牙设备：

- 按住 SB 120 底座控制面板上的“SOURCE (来源)”按钮 3 秒钟
- 关闭已配对设备的蓝牙功能
- 按下 Klipsch SB 120 底座遥控器上的蓝牙按钮

按钮

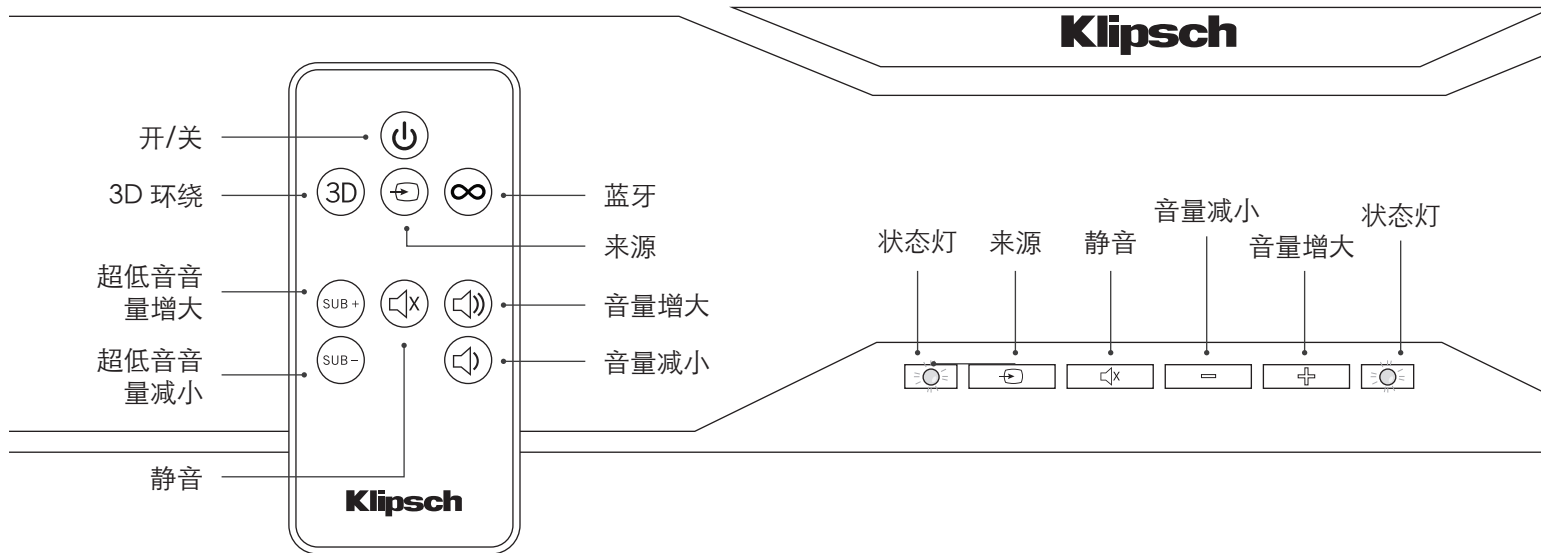

状态灯 (右的状态指示灯, 除非)

红灯常亮 关机 (待机模式)

绿灯常亮 开机, 来源为光纤输入

橙灯常亮 开机, 来源为模拟输入

蓝灯常亮 开机, 来源为配对的蓝牙设备

绿/橙/蓝灯闪烁: 音量增大、音量减小或超低音
音量增大/减小按钮已按下

绿灯闪烁一次 3D 环绕已开启

红灯闪烁一次 3D 环绕已关闭

蓝灯快闪 等待与蓝牙设备配对

紫灯慢闪 SB 120 底座正在解码杜比数字音频

白色 (右侧状态指示灯) 3D 环绕模式

待机模式

无需关闭 SB 120 底座, 关闭电视机 (或卫星/有线电视顶盒) 约 10 分钟后, Klipsch SB 120 底座将自动进入待机模式。

前面板的红色状态灯指示待机状态。再次打开电视机 (或卫星/有线电视顶盒) 时, SB 120 底座将再次自动启动。

放置

电视机的重量应小于 100 英磅 (45kg)

电视机底座应小于 31 英寸 x 11 英寸
(78cm x 28cm)

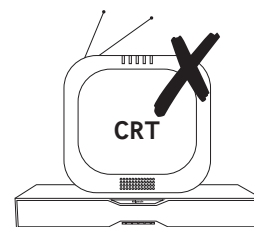
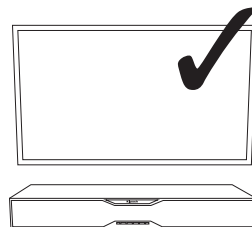
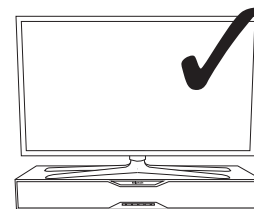
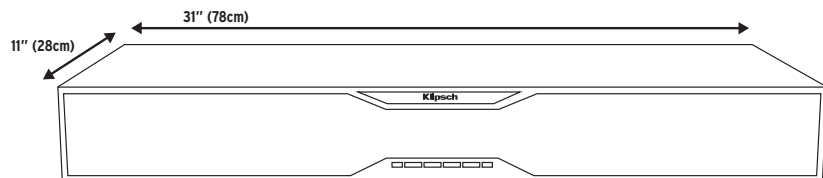

请确保 SB 120 底座的后部距墙至少一英寸，其顶部和侧面也应保留至少一英寸的空隙，以便通风。

关闭电视机扬声器



(推荐)

或者

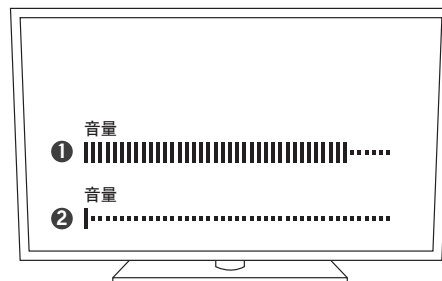

保养与清洁

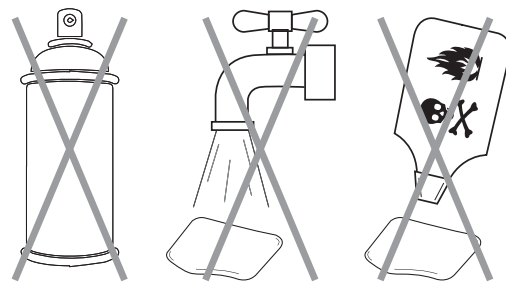
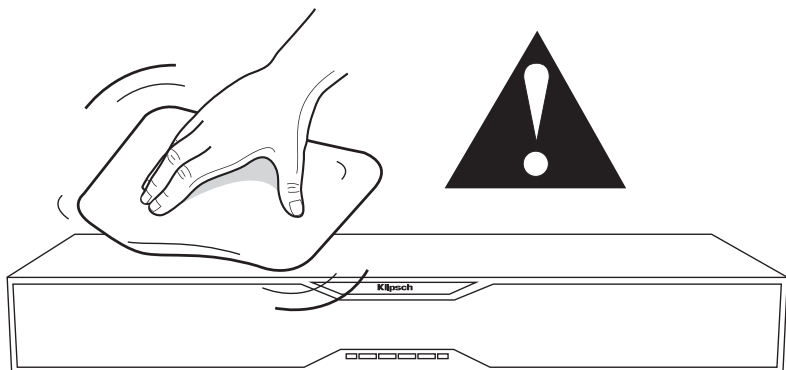

故障排除

SB 120 底座无法开机

- 是否连接了通电的电源插座？
- 后部的电源开关是否打开？

没有声音

- 是否连接了通电的电源插座，后部的电源开关是否打开？
- 是否电视机/有线电视机电顶盒/卫星电视机顶盒的所有引出线都已插牢？
- 如果使用光纤，光纤两端的透明塑料帽在连接前是否已取下？
- 音量是否已调高？
- 是否关闭了待机模式（状态灯不是红色常亮）？
- 输入源是否正确？
- 关闭并打开后部的电源开关。

无法对电视机/有线电视机电顶盒/卫星电视机顶盒遥控器编程

- 严格遵循所有遥控器编程说明。
- 使用电视机原装的遥控器再次进行遥控编程。无需使用有线电视/卫星电视/通用遥控器再次编程。
- 对电视机原装的遥控器编程，并同步至 SB 120 底座（如果原装遥控器为另一遥控器），再使用通用遥控器但不需要编程。
- 有些情况下，须重复对某一功能编程。
- 有些情况下，SB 120 底座无法学到特定的远程代码。

蓝牙流媒体功能不正常

- 蓝牙设备是否已与 SB 120 底座配对？
- 让蓝牙设备靠近 SB 120 底座，确认设备已配对。
- 如果配对时状态灯闪烁红光，请重新开始配对。

如有疑问，请联系 Energy 客户服务中心：

美国：1-866-441-8208



杜比实验室授权制造。Dolby 和双 D 标志为杜比实验室的注册商标。

Bluetooth® 文字商标和徽标为 Bluetooth SIG, Inc. 的注册商标，Klipsch Group, Inc. 对该商标的使用均得到授权。







Klipsch[®]

KEEPERS OF THE SOUND[™]

3502 WOODVIEW TRACE, INDIANAPOLIS, IN, USA

klipsch.com

©2013, Klipsch Group, Inc.
Klipsch Group, Inc. is a wholly-owned
subsidiary of Vox International Corporation.